



This is a digital copy of a book that was preserved for generations on library shelves before it was carefully scanned by Google as part of a project to make the world's books discoverable online.

It has survived long enough for the copyright to expire and the book to enter the public domain. A public domain book is one that was never subject to copyright or whose legal copyright term has expired. Whether a book is in the public domain may vary country to country. Public domain books are our gateways to the past, representing a wealth of history, culture and knowledge that's often difficult to discover.

Marks, notations and other marginalia present in the original volume will appear in this file - a reminder of this book's long journey from the publisher to a library and finally to you.

Usage guidelines

Google is proud to partner with libraries to digitize public domain materials and make them widely accessible. Public domain books belong to the public and we are merely their custodians. Nevertheless, this work is expensive, so in order to keep providing this resource, we have taken steps to prevent abuse by commercial parties, including placing technical restrictions on automated querying.

We also ask that you:

- + *Make non-commercial use of the files* We designed Google Book Search for use by individuals, and we request that you use these files for personal, non-commercial purposes.
- + *Refrain from automated querying* Do not send automated queries of any sort to Google's system: If you are conducting research on machine translation, optical character recognition or other areas where access to a large amount of text is helpful, please contact us. We encourage the use of public domain materials for these purposes and may be able to help.
- + *Maintain attribution* The Google "watermark" you see on each file is essential for informing people about this project and helping them find additional materials through Google Book Search. Please do not remove it.
- + *Keep it legal* Whatever your use, remember that you are responsible for ensuring that what you are doing is legal. Do not assume that just because we believe a book is in the public domain for users in the United States, that the work is also in the public domain for users in other countries. Whether a book is still in copyright varies from country to country, and we can't offer guidance on whether any specific use of any specific book is allowed. Please do not assume that a book's appearance in Google Book Search means it can be used in any manner anywhere in the world. Copyright infringement liability can be quite severe.

About Google Book Search

Google's mission is to organize the world's information and to make it universally accessible and useful. Google Book Search helps readers discover the world's books while helping authors and publishers reach new audiences. You can search through the full text of this book on the web at <http://books.google.com/>

NYPL RESEARCH LIBRARIES



3 3433 06637847 6

1., U.S.
T.D.

Alvora
- VIN

T

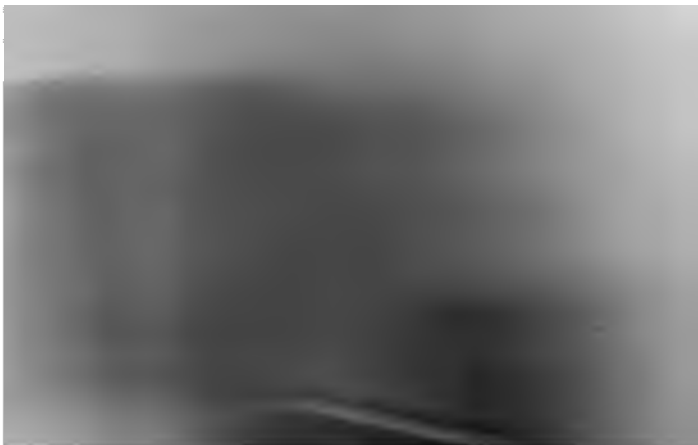

RELIEF FROM FLOODS

1872

1873

1874

1875

1876

1877

1878

1879

1880

1881

1882

1883

1884

1885

1886

1887

1888

1889

1890

1891

1892

1893

1894

1895

1896

1897

1898

1899

1900

1872

RELIEF FROM FLOODS

THE FUNDAMENTALS OF FLOOD PREVEN-
TION, FLOOD PROTECTION AND THE
MEANS FOR DETERMINING
PROPER REMEDIES

BY
JOHN W. ALVORD
AND

CHARLES B. BURDICK

MEMBERS AMERICAN SOCIETY OF CIVIL ENGINEERS
CHIEF ENGINEERS FRANKLIN COUNTY CON-
SERVANCY DISTRICT, CONSULTING
HYDRAULIC ENGINEERS

FIRST EDITION

McGRAW-HILL BOOK COMPANY, Inc.
220 WEST 23RD STREET, NEW YORK

LONDON: HILL PUBLISHING CO. Ltd.

1 & 2, BUNNERS ST. E. C.

1918



McGraw-Hill Book Co. Inc

PUBLISHERS OF BOOKS FOR

Coal Age ∇ Electric Railway Journal
Electrical World ∇ Engineering News-Record
American Machinist ∇ The Contractor
Engineering & Mining Journal ∇ Power
Metallurgical & Chemical Engineering
Electrical Merchandising

RELIEF FROM FLOODS

THE FUNDAMENTALS OF FLOOD PREVEN-
TION, FLOOD PROTECTION AND THE
MEANS FOR DETERMINING
PROPER REMEDIES

BY
JOHN W. ALVORD
AND

CHARLES B. BURDICK

MEMBERS AMERICAN SOCIETY OF CIVIL ENGINEERS
CHIEF ENGINEERS FRANKLIN COUNTY CON-
SERVANCY DISTRICT, CONSULTING
HYDRAULIC ENGINEERS.

FIRST EDITION

McGRAW-HILL BOOK COMPANY, Inc.
239 WEST 39TH STREET. NEW YORK

LONDON: HILL PUBLISHING CO., Ltd.
6 & 8 BOUVERIE ST., E. C.

1918

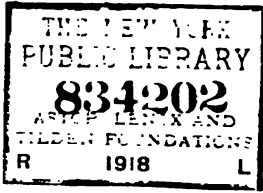

COPYRIGHT, 1918, BY THE
MCGRAW-HILL BOOK COMPANY, INC.

PREFACE

It is not the purpose to present in this book a treatise on flood relief. The aim has been rather to outline briefly the general flood problem in all its many phases, to show what remedies can be applied, and to point out the way to the selection of the proper works. An effort has been made to avoid technicalities; and while this has been difficult, especially in the consideration of channel improvements, it is hoped that the subject matter will be readily understandable even to readers who are not engineers or students of engineering.

Although great floods are constantly occurring in various parts of the country, they happen infrequently in the same locality. They come unexpectedly, and as they pass, they leave the community with the desire for better conditions but with considerable bewilderment as to how they shall be secured. There is a lack of appreciation of the problem and an absence of knowledge, even among some engineers, as to what shall be done to determine proper measures for relief, to ascertain what fundamental data is reasonably required, and to determine what investigations and studies must be made before the proper remedy can be selected. Everyone wants to see the dirt fly. It is the tendency to be intolerant of the time spent in investigation, and yet nothing good can be accomplished without a proper amount of such preliminary work. Some phases of this matter have received much thought in the past, but it is only recently that the number of problems carefully studied has been great enough to warrant a clear-cut outline of the field, and to demonstrate that nearly every remedy has its specific place.

Pardon must be asked for the frequent references to the great floods in Ohio. While these floods are among the

most important of modern times, flood situations elsewhere have been equally important. The authors must plead a particular familiarity with the Ohio problems rather than an exaggerated idea of the importance of these problems, as an excuse for their frequent mention.

CONTENTS

	PAGE
PREFACE	v
CHAPTER I	
THE FLOOD PROBLEM	1-27
Importance, 1—United States Flood Losses, 4—1913 Flood Losses, 4—Damage at Dayton, 5—Scioto Valley, 5—Pittsburgh, 6—Other Flood Losses, 7—Causes of Floods, 9—Variation in Flood Flow, 9—Factors Affecting Stream Flow and Floods, 10—Precipitation, 11—Watershed Area, 12—Natural Storage, 13—Climate, 15—Flood Tendencies, 16—Records and Popular Beliefs, 17—Rainfall Records, 18—River Gage Heights, 19—Flood and Runoff Studies, 21—Merrimac River, 22—Wisconsin Studies, 23—Basis for Popular Belief, 26—Flood Tendencies Summarized, 27.	
CHAPTER II	
VARIOUS MEANS FOR RELIEF	28-44
Importance of Considering all Reasonable Means, 28—General Types of Flood Relief, 28—Diversion Works, 30—Preventive Works, 32—Reservoirs for Flood Protection, 32—Main Purpose of Storage Reservoirs, 33—Detention Basins, 35—Storage vs. Detention Basins, 35—European Experience, 36—French Experience, 37—German and Austrian Experience, 37—Other Countries, 40—Flood Relief in America, 40—Lower Mississippi, 40—Mississippi Reservoir System, 42—Ottawa River Project, 42—Pittsburgh Project, 43—Ohio Flood Problems, 43.	
CHAPTER III	
FLOOD INVESTIGATIONS	45-54
Demand for Haste, 45—Stages of a Public Work, 45—Psychology of Reporting, 46—Publication of Data, 47—Frankness and Impartiality, 47—Conservatism, 49—Selecting the Best Project, 50—Financial Practicability, 51—Half-way Measures, 52—Partial Protection, 53.	
CHAPTER IV	
FUNDAMENTAL DATA	55-81
Necessity for Full Determination of Facts, 55—Investigations Relating to Values and Losses, 56—Indirect Losses, 58—Bank Clearings, 60—Annual Flood Losses, 60—Physiography, 61—	

	PAGE
Usefulness of Surveys 61—Underground Conditions 65—In-	
vestigations Relating to Hydrology 66—Gaging Stations 67—	
Rating Curves 68—Construction of Rating Curves 69—Flood	
Measurements 71—A Dam as a Weir 72—Observations as a	
Flood Index 73—Slope Measurements 73—Hydrographs 75—	
Influence of Rainfall 75—Area of Storm 77—Prediction of	
Rainfall 77	

CHAPTER V

HYDROLOGIC FACTORS 82-93	82-93
History on Basis of Forecast 82—Flood History 82—Floods on	
Annual Basis 83—Effect of Changes of Climate on Rivers 84—	
History of the River Basin 84—Karl Ludwig's Data 84—Floods on	
Basins 87—Twenty-four Hour Averages 88—Flood Fore-	
cast 88—Floods Formed by Forecast Floods 92	

CHAPTER VI

HYDROLOGICALLY CHANNEL IMPROVEMENT 94-127	94-127
Water Application of Rivers 94—Channel Improvement 94—	
Channel Improvement 95—River Basins 96—Floods 97—	
Use of Flooded Bottomland 97—Structures 98—Flood	
Plains and Land Reclamation 99—Floods 100—Floods 101—	
Levees and Water Storage 103—Channel Improvement 104—	
Prevention of Levees 106—Causes of Flood Damage 108—Flood	
Damage Levees 109—Levee Inspection 111—Levee Safety	
Prevention of Levee Damage 112—Levee Safety 113—	
Structures on Hydrology 118—Levee Safety 119—	
Annual Levees 122—Flooded Channels 123—Flooded	
Channels 125	

CHAPTER VII

HYDROLOGICALLY WATER STORAGE 128-156	128-156
Distribution of Stream Flow 128—Seasonal Distribution 129—	
In-channel Storage 131—Conflict of Purposes 131—Storage of	
Floods 131—Continental Storage on Southern Continent 132—	
Relation between Storage Volume and Flood Recurrence 133—	
Location of Flood Reservoirs 137—Large Levees 139—	
Basins 140—Automatic Operation 141—Dam Reservoirs 142—	
Land 142—Spillways 145—Outlets 145—River Dams 148—	
Water Conservation 150—Dixton Dam Reservoirs 151—	
Works for State Army 153—Operation of Reservoirs 154—	
Operation of Danawan Basin 156—Basins for Flood Storage 156—	
162—Large Channels Must Govern Levees	

APPENDIX

INDEX

RELIEF FROM FLOODS

CHAPTER I

THE FLOOD PROBLEM

At present the flood problem occupies an important place in the public thought. Few will deny that floods are becoming increasingly important. They are thrust upon our notice with greater frequency, and the toll of life and property becomes greater with each decade. This view is not dependent upon the assumption that our climate is changing, not even that the runoff of our streams is becoming greater. The march of civilization, not content with occupying our highlands, has already appropriated our lowlands to its uses. The farmer has diked the alluvial river valleys, the city has appropriated them for streets, homes and factories, the railroads have utilized the easy grades of the flood plane and have occupied it with embankments, and have crossed and recrossed the streams with bridges, proportioned often by what the eye of the builder could see of the river at the time. All these things are abundantly sufficient to account for our rapidly mounting flood losses.

The retreat of civilization is not to be thought of. No one will seriously consider the abandonment of our richest agricultural lands, nor our most valuable commercial highways. We cannot go back to the day of the Indian and the buffalo even if we would do so. We must accept the conditions as they are, modify them as intelligently as

possible, and in the future we must see that our ends are accomplished with due regard to adequate drainage, considering not only the usual conditions of rainfall and runoff, but where conditions warrant, the extraordinary as well. A way can always be found to satisfy the requirements of nature without defeating the legitimate purposes of civilization. The ways and means are largely matters of cost. Once the conditions surrounding a particular problem are clearly defined, it can be determined how far remedies will be effective and how far costs will be warranted.



FIG. 1.—The best residential district of Dayton was flooded

Some of our flood problems are local, but we hear little of them. Those that come to public notice are the larger problems, and unfortunately the conditions that surround them are not easily determined. Considerable labor is required. The public is always impatient of study. It wants to see the dirt fly. It will wait, however, if the necessity for time and study is shown. It is the object of the pages which follow to make the task of

education easier by outlining the flood problem in its principal phases, to outline the remedies most generally applicable, and to acquaint public leaders, particularly technical men, with the process of inquiry by which the right remedy for the particular case can be found.

FLOOD DAMAGE

Although flood losses have been large in this country for a number of years, there are as yet no comprehensive statistics showing the flood loss in total. The only figures reaching the notice of the writers attempting to



FIG. 2.—Cleaning up after the Dayton flood.

cover the country as a whole, are those prepared by Mr. M. O. Leighton, and published by the U. S. Geological Survey.¹ This estimate covers the years from 1900 to 1908, and is as shown in Table I.

Since the last year covered by the following estimate, there have been one or two years when the total loss probably considerably exceeded any year covered by the table.

¹ *Water Supply Paper 234*, U. S. Geological Survey, p. 25.

RELIEF FROM FLOODS

TABLE I.—TOTAL ESTIMATED FLOOD LOSSES OF THE UNITED STATES,
1900 to 1908

1900.....	\$45,675,000
1901.....	45,438,000
1902.....	55,201,000
1903.....	97,220,000
1904.....	78,841,000
1905.....	98,589,000
1906.....	73,124,000
1907.....	118,238,000
1908.....	237,860,000

1913 Flood.—The U. S. Department of Agriculture¹ estimates the 1913 flood loss in the Mississippi Valley and Northeastern States as follows:

TABLE II.—ESTIMATED FLOOD LOSSES IN THE MISSISSIPPI VALLEY AND
NORTHEASTERN STATES, FLOOD OF 1913

OHIO RIVER DISTRICTS: ²	
Pittsburgh District.....	\$2,725,000
Parkersburg District.....	2,451,000
Cincinnati District.....	3,891,050
Louisville District.....	1,300,000
Evansville District.....	2,325,000
Cairo District.....	1,290,000
Cumberland River at Nashville.....	207,200
White River, Indiana.....	5,596,105
Wabash River, Indiana.....	10,000,000
Smaller rivers of Ohio.....	106,674,404
MISSISSIPPI RIVER DISTRICTS:	
Memphis District.....	5,605,040
Vicksburg District.....	1,625,000
New Orleans District.....	565,750
Upper Hudson and Mohawk Rivers,	
Albany District.....	1,100,000
Connecticut River Valley in Vermont.....	37,500
Railroads throughout the flooded district.....	16,168,565
Loss to telephone and telegraph companies.....	2,003,179
Total for entire flooded district.....	\$163,564,793

¹ *Bulletin Z.*, "Floods of 1913."

² U. S. Geological Survey estimates losses for Watershed of Ohio River alone at \$180,873,097—*Water Supply Paper* 334, p. 85.

This flood was caused by a very excessive rainstorm covering the northeastern Mississippi Valley and extending to New England. The greatest precipitation and the greatest damage was caused in Ohio, particularly on the Miami and Scioto Rivers. Dayton was the chief sufferer. The Dayton Citizens' Relief Committee after a careful investigation of all interests and the personal investigation of 2,164 residences in the flooded zone, estimates the flood loss in Dayton as follows:

TABLE III.—ESTIMATED FLOOD LOSS IN DAYTON, OHIO, 1913 FLOOD

Loss of public property.....	\$2,068,100
Loss to public utilities including railroads..	5,884,573
Loss to public utilities on account of loss of business.....	838,631
Fire loss over insurance.....	975,236
Damage to buildings.....	15,200,000
Damage to household furniture and fur- nishings.....	9,440,000
Loss to merchants on stock and fixtures...	18,000,000
Loss to live stock, automobiles and vehicles.	1,000,000
Factory losses, wages.....	4,045,000
Factory, stock and machinery.....	8,747,500
Factory business losses.....	1,900,000
Loss of contracts, rentals, etc.....	3,450,000
Pianos in homes.....	800,000
Leaf tobacco in warehouses.....	900,000
Total.....	<u>\$73,249,040</u>

After Dayton, Hamilton was the principal sufferer. It sustained an estimated flood loss of \$9,723,801.

The most serious aspect of the Ohio flood was the great loss of life. Over 100 municipalities in the State were affected by the flood. The number of lives lost is estimated at 467. There were approximately 40,637 residences flooded and 2,220 houses destroyed.

Scioto Valley.—In the valley of the Scioto River the direct flood loss of 1913 is estimated at \$10,572,100. It is estimated that the indirect losses are sufficient to bring the total up to more than \$25,000,000. The City of Columbus was the chief sufferer, sustaining a direct loss of \$5,291,000,



FIG. 3.—General view of the March, 1913 flood at Columbus, Ohio. Normally the river occupies the narrow channel in the foreground.

and the total loss, including the indirect losses, was \$14,361,000. Ninety-three lives were lost in Columbus, and 145 lives were lost in the entire Scioto Valley. A population of about 235,000 was directly affected. It is estimated that a population of 35,200 were driven from their homes by the flood.

There have been two disastrous floods in the Scioto Valley within the past 20 years. It is estimated that the losses from these two floods, with smaller losses from several other floods, aggregate an annual loss of about \$1,500,000.

Pittsburgh.—The City of Pittsburgh has been visited by numerous floods causing great damage, particularly the floods of 1907 and 1908. It is estimated that about 1,600 acres of land in Pittsburgh were covered by the 1907 flood, overflowing property valued at about \$150,000,000. The Pittsburgh Flood Commission in its report of 1912 estimates the total direct loss from March 15, 1907, to March 20, 1908, at \$6,514,000. The Commission further estimates that in the past 20 years the losses due to flood

damage in the City of Pittsburgh alone have amounted to about \$17,000,000, over \$12,000,000 of which occurred in the 10 years preceding January, 1911.

Other Floods.—The year 1907 was a bad flood year throughout the Ohio River watershed. The Indiana Waterways Commission estimates the total flood loss along the Ohio River for the year 1907 at over \$100,000,000.



FIG. 4.—The Sullivant Ave. Subway, on the B. & O. R. R., Columbus, Ohio, after the March, 1913, flood.

The wreckage of the steel superstructure lies concealed in the pool in the foreground. The hole eroded by the flood waters here is about 18 feet deep. The flood waters passed through this subway from right to left in the picture. It was the torrential velocities through this and other subways that caused the greatest loss of life and destruction of property.

The year 1914 witnessed very severe floods in California, particularly in the vicinity of Los Angeles. The report of the Board of Engineers bearing date of July 27, 1915, states that "the loss by flood in Los Angeles County in 1914 has been estimated at \$10,000,000, exclusive of harbor damages."

Within the past 10 years floods causing excessive damage have occurred at Kansas City, Denver, and Erie, Pa., and in addition to these localities and those previously mentioned, which have sustained unusually heavy losses,



FIG. 5.—The great flood in business district of Dayton.

the annual loss in the valley of the lower Mississippi has been unusually great, notwithstanding the improvement of the levee system, by reason of the very excessive floods here in the past 5 years. Previously reported gage heights have been exceeded twice at Cairo since 1912.

It is hoped that the figures given above will serve to visualize the magnitude of the flood problem in this country. That which has been lost can never be recovered. The statistics, however, can serve as a guide to those localities where extensive flood relief works are warranted, and the probable annual losses over a period of years will serve to fix warranted expenditures. In this connection it should not be forgotten that the annual flood loss will continue to increase with the population of our river bottoms except where corrective measures are taken. It is, therefore, the future flood losses without protection that will warrant the expenditures for relief.

THE CAUSES OF FLOODS

It is obvious that before a remedy for the flood situation can be intelligently applied, we must know something about the causes of floods and the factors that affect their intensity.

Flood is a relative term. As usually understood, it is comparatively a great flow of water. Webster defines it as a great flow of water; a body of water rising, swelling and overflowing land not usually covered with water. Thus, we term the spring runoff of a river a spring flood because it is a great flow as compared to the ordinary seasonal river flow, and likewise the great floods are those floods comparatively large when compared to the ordinary floods of the locality. It follows, therefore, that wherever we have rainfall in excess of the absorption capacity of the soil, floods will occur of greater or less magnitude. They occur in the arid regions as well as the humid tropics. If great floods had substantially the same magnitude on all streams, the problem of flood relief would be materially simplified. The following maximum flood rates upon rivers of America, taken at random, will serve to emphasize the wide variation in flood flow.

TABLE IV.—ILLUSTRATING WIDE VARIATION IN FLOOD FLOW

River	Place	Drainage area in square miles	Date of flood	Flood discharge, second-foot per square mile
Mississippi.....	At mouth.....	1,240,050	1913	2.00
Illinois.....	At mouth.....	27,914	1904	4.48
Ohio.....	At Cairo.....	233,000	1913	6.00
Grand.....	At Grand Rapids, Mich.....	4,900	March, 1904	8.04
Ohio.....	At Cincinnati.....	75,800	1913	8.70
Wisconsin.....	At Kilburn.....	8,000		10.00
Ohio.....	At Wheeling.....	34,800	1913	18.10
Muskingum.....	At Marietta, Ohio....	78,500	March, 1913	32.00
Scioto.....	At Columbus Storage Dam.....	1,032	March, 1913	77.00
Miami.....	At Dayton, Ohio....	2,450	March, 1913	100.00
Chagres River...	At Bohio, Panama....	797	Dec., 1909	115.00
Santa Catarina...	At Monterey, Mexico..	544	June, 1909	590.00
Devils Creek....	Near Viele, Iowa....	143	June, 1905	1,300.00
Willow Creek...	Near Heppner, Ore....	20	June, 1903	1,800.00

Much smaller flood rates than any mentioned above are to be found upon the rivers of the semi-arid western United States, and flood-flow rates in excess of the largest figures above mentioned are on record, as the result of cloudbursts on very small drainage areas.



FIG. 6.—Wreckage in wake of Columbus, Ohio, flood, March, 1913.

With the above figures before us showing the very wide variation in stream flow, it will be of interest to note the factors that contribute to this great diversity in runoff rate.

Factors Affecting Stream Flow and Floods.—A great flood is the result of an unfortunate combination of circumstances, the more important of which are the intensity of the rainfall, the size, shape, topography and geology of the watershed, and the climate of the region. The three principal contributing causes above mentioned may be subdivided into an endless number of minor contributing causes. The following tabulation sets forth the principal contributing factors.

FACTORS THAT AFFECT STREAM FLOW AND FLOODS

Precipitation	}	Amount Seasonal distribution Intensity, area, duration and direction of storms Precipitation as snow		
Watershed	}	Size Shape Arrangement of tributaries Topography Surface Subsoil Lakes, ponds and swamps Vegetation Works of man { <table border="0" style="display: inline-table; vertical-align: middle;"> <tr> <td style="font-size: 2em; vertical-align: middle;">}</td> <td> Agriculture, irrigation Drainage Dams and reservoirs </td> </tr> </table>	}	Agriculture, irrigation Drainage Dams and reservoirs
}	Agriculture, irrigation Drainage Dams and reservoirs			
Climate	}	Freezing as arresting flow Freezing as affecting ground surface Accumulation of snow Suddenness of spring flows As affecting vegetation Ice gorges		

Precipitation.—We cannot have floods without precipitation either in the form of rain or snow, although the greatest floods do not necessarily occur in the regions of greatest rainfall. Those regions having a copious and well-distributed rainfall are most likely to shed the water of an intense storm most rapidly on account of the subsoil being already well saturated.

The floods of the great rivers like the Mississippi and the Ohio are occasioned by general heavy rains of considerable duration, particularly if they fall upon melting snow, or if the runoff reaches the main water courses at a time coincident with the runoff from the melting snows. Floods on such rivers may also be caused by a series of great storms more or less local, particularly if the storms occur at such times and places that the runoffs coincide in the main stream. The great floods of 1913 upon the Mississippi and Ohio Rivers were caused by an unusually excessive storm extending principally across the northern tributaries of the Ohio.

The streams of more moderate size, say from 1,000 to 25,000 square miles in drainage area, are usually most greatly affected by such rainstorms as that of March, 1913, in which an excessive downpour occurred over substantially the whole watershed of the stream for a sufficient time so that all parts of the watershed were simultaneously contributing to the flood in the main water course.

The smaller the watershed the greater the likelihood that it will be entirely covered by an excessive rainstorm, and the smaller the watershed, the shorter the duration of the storm that will be required to make each part of the watershed simultaneously contribute to the main stream. Thus, on small watersheds, a short, sharp storm may produce a great flood.

Cherry Creek at Denver has a drainage area of 412 square miles. In 1912 a rainstorm lasting only about 2 hours produced a disastrous flood. The total rainfall was 2.08 inches; 1.62 inches fell in 20 minutes, and 0.87 inch in 5 minutes. A storm of such short duration would have no great effect upon a river of 5,000 to 10,000 square miles drainage area. The disastrous flood of Erie, Pa., in 1915, was occasioned by a short, sharp storm lasting only four hours, falling upon a watershed of 12.9 square miles.

In the Mississippi Valley, embracing 1,240,050. square miles, the extremities of the drainage area are sufficiently remote so that a drouth upon one border may be coincident with a deluge upon the other. No great rainstorm has ever covered all at once, and probably never will.

Watershed. - The size of the watershed, therefore, has an important effect upon the rate of flood runoff. The shape of the watershed also affects the flood rate. Thus, if a watershed is long and narrow, it may have a less unit flood runoff than if it should be more nearly circular form, particularly when, in the latter case, the tributaries radiate radially from the border of the drainage area, to bring the flood waters simultaneously to

one place. In the long and narrow drainage area it often happens that the drainage from the downstream watershed passes away before the waters from the upper tributaries reach the lower parts of the drainage area.

A very important contributing factor is the surface topography. The flat prairie lands of Illinois are slowly drained in a great storm. Each field becomes a detention basin contributing the water slowly to the wide flat valleys of the minor streams, which in turn give up their waters slowly to the principal rivers. Upon the other hand, the roof-like hillsides of Pennsylvania, the Appalachian region, some parts of Ohio and other places in the Middle West deliver the rainfall so rapidly to the main streams that heavy storms of comparatively short duration may produce excessive flood rates.

The rapidity of runoff is also greatly affected by the character of the ground surface, as to its quality of shedding the rain or absorbing it. Upon the lower Peninsula of Michigan, we have an example of highly absorptive surface, gentle slopes and a deep and capacious subsoil of sand and gravel. In some localities all the rainfall is absorbed by the surface. Surface streams are absent over considerable areas. A large part of even the very heavy rainfalls is absorbed by the sandy soil and given up to the stream gradually in the form of springs and seepage. The fact that the ground is sometimes frozen in times of spring rains apparently has not caused floods greater than about 10 second-feet per square mile for the principal rivers of the State.

Upon the other hand, such watersheds as the Scioto and Miami in Ohio are largely underlaid by rock at no great depth. The overlying materials, although often of a gravelly nature, are interspersed with clay to such extent as to be highly impermeable and comparatively non-absorbent. Similar conditions exist generally throughout the major part of the Ohio River watershed, and except for its great size, the unit flow rate would be very excessive.

Natural Storage.—Natural storage in lakes, ponds and

swamps has an important effect upon floods. Probably no stream in the country is more uniform in its flow than the St. Lawrence River which is fed by the natural reservoir system of the Great Lakes. The total watershed at the head of the river is 287,688 square miles, of which 33 per cent. is water surface. The mean runoff from Lake Ontario is nearly 1 second-foot per square mile, and the flow of the maximum month is only 44 per cent. greater than the flow of the average year. Lake-fed streams show a similarity in flow depending upon the extent of the water areas in comparison with the total watershed. Upon most of our streams, however, lakes, ponds and swamps constitute a very small part of the tributary drainage area.

Beyond question the surface vegetation plays its part in reducing the runoff, and to some extent in reducing the excessive runoff rates in floods. Much has been written relative to the effect of the forests upon the flow of the streams. There are doubtless some conditions under which forests can exercise a noticeable effect upon stream flow, but the influence of the forests is believed to be greatly exaggerated by many of the writers upon forestry. We will consider this matter somewhat further in discussing the subject of flood tendency.

The works of man have their influence upon stream flow, particularly the smaller streams. Man's influence upon vegetation has had its effect. The tilled field absorbs the rainfall rapidly up to a certain depth and some forms of vegetation, particularly the meadow and the grain field, possess the ability temporarily to store considerable water. In the barren season of the year the influence of vegetation except heavy brush is slight, and frozen fields will shed the water readily. A conspicuous example of man's handiwork is found in the drainage of the swamps through the construction of ditches, the improvement of the river channels and through the tile drainage of land. This has been practised very extensively in the prairie States of the Middle West. Where lakes and swamps have been destroyed that were capable of storing a considerable depth of water,

the tendency has been to increase the stream flows in the wet season and diminish the flow in drouth. Upon the other hand, ground that is permanently wet cannot absorb rainfall, and therefore the drainage of the swamps and the lowering of the water table sufficiently to permit of agriculture has created an underground reservoir that did not exist in the state of nature. This is particularly important where the higher land has been underdrained, in that the tile drainage has lowered the water table and opened up the soil to such extent that much water formerly flowing off over the surface is delivered gradually to the underdrains. One cannot examine the outlet of a large drainage system from an upland farm even long after the rains have passed without being impressed with the importance of the storage capacity which has thus been added to the water drainage system.

It is hardly necessary to mention the influence of artificial works particularly designed to influence stream flow such as the reservoir systems of the upper Mississippi, and the works for flood relief that are now being projected in this country. The construction of mill dams has had an important influence on some of the small streams. Levees for the reclamation of farm lands have had an important effect upon the flood heights of the Illinois River, and to a slight extent upon the maximum flood flow on account of the river-valley storage that has been destroyed by the reclamation of the farm lands. The encroachments of the cities have had an effect upon flood heights, and the same may be said for railroad embankments and bridges in some important instances. All these things influence stream flow and floods by their effect upon the watershed upon which the rain falls. There remains the additional effect of climate.

Climate.—Although the torrid zone has its floods as well as the temperate zone and the arctic regions, climate has an important influence in the relation between the rain storm and the resulting runoff. The most important effect is that of frost, which destroys much of the vegetation, and covers even the most open prairie with a mass of ice

impenetrable coating. On any watershed a given storm will produce a greater flood in the barren and frozen season of the year.

Freezing weather has a further effect in temporarily arresting all flow if the cold is very excessive, and where the cold is sufficiently continuous the climatic influence is very important in the accumulated snow blanket and its sudden release upon the approach of warm weather, particularly if accompanied by rain. In the rivers of the North, the heavy formation of ice exercises an important influence upon flood heights, particularly on account of gorges in that season of the year when the ice may be broken up and floated away by spring rains. The effect of ice gorges is particularly important upon some of the streams flowing north where the ice first breaks up in the headwaters of the river, producing an accumulation of floating ice as the warm weather travels toward the mouth of the stream.

We have mentioned above the principal factors affecting stream flow and floods. Many other minor factors might be mentioned. Practically all the rivers of the temperate zone are influenced more or less by all these factors, and the wide variation in flood flow is accounted for by different combinations of factors. The predominant factors in the well-watered parts of the country appear to be those related to the drainage area, particularly as to the opportunity offered for water storage either above or below the ground surface. All the other factors are minor except in special cases.

FLOOD TENDENCIES

There is a widespread belief that the flow of our streams is becoming more irregular, that floods are becoming greater and more frequent, and that the low-water periods are more accentuated. The belief is quite common that the cutting of the forests has been the largest contributor to this condition. This belief is not of recent origin, but prevailed 40 years ago. It has not received more or less support

to time, particularly during the last 15 years, in which conservationists have made use of it as an argument for the preservation of the forests, and it has even been urged upon Congress that the preservation of the forests has an important effect upon navigation and, therefore, that Congress should promote forestry through its power to regulate Interstate Commerce.

If it is true that the floods are becoming materially greater and more frequent, then all should be advised of it, and works for flood relief should be proportioned accordingly. It will not be sufficient then to provide for the greatest known occurrences of the past, but the extent of the increasing tendency must be determined, and the works must be designed with excessive capacity for present requirements, or provision must be made for increasing their capacity in the future.

As a measure of relief from the present floods, the restoration of the forests is not a live question, for except in a few cases where the land is very poor, there is no prospect that the requirements of agriculture and the increasing public demand for food will ever permit of reforestation of agricultural lands, regardless of any effect it might have upon stream flow, and if reforestation were practicable, the time required for it to become effective would preclude its usefulness for a long time in the future. It is valuable, however, to the flood-relief problem to dispose of the question as to the trend of flood tendencies, so far as the data will permit.

Records and Popular Beliefs.—At the outset let it be understood that the records abundantly prove the variability of climate and rainfall, and hence the flow of the streams is exceedingly variable. Geologic history also shows that permanent changes, very great in amount, have occurred in the history of the world through causes of which there is more or less speculation. The changes, however, so frequently referred to, relate to the last century or two, particularly to the last 50 years in America, during which the greater part of the deforestation has occurred.

It must further be conceded that our accurate records of climate and stream flow are not sufficiently lengthy to determine small tendencies, in view of the great variability of the totals and the large number of contributing factors. We have, however, a few records of rainfall and stream gage heights that are continuous for about 100 years, and quite a number from 25 to 50 years in length. In Europe they have records of the great floods upon a few streams dating back many centuries. Let us examine the more important of these data to see what is shown, and let us review some of the findings of those who have given the records a thorough study.

Rainfall Records.—Although rainfall is the principal factor in the creation of floods, it is difficult to define the rainfall in terms of its effect upon the flow of streams, for the greatest rainfall in a given time does not always produce the greatest flood. It has been claimed, however, that changes brought about by civilization, particularly the cutting of the forests, has had the effect of reducing the rainfall. As particularly bearing upon this matter, and also to illustrate the importance of long records, when statistics of climate are to be compared, Fig. 7 has been prepared, which shows five of the longest rainfall records in the United States.

The diagram indicates the total for each year at each place, compared to the mean rainfall for the total period. It will be observed that some years materially exceed the mean, and in other years the rainfall is materially less. There are groups of wet years and groups of dry years, and yet it cannot be said that there is any marked tendency for increase or decrease when the whole period is considered.

The danger of attempting deductions from a short record is well illustrated by comparing portions of these diagrams; thus, taking the Boston record, if we had before us only the record from 1845 to 1870, the conclusion might be indicated that the rainfall was increasing. Upon the other hand, with the period before us from 1860 to 1890, the reverse would be indicated. The past decade at Boston has been

one of extremely low total rainfall, and yet similar decades occurred in the twenties and thirties. The diagrams for the other rainfall stations illustrate similar conditions, although the extremes are less marked than at Boston.

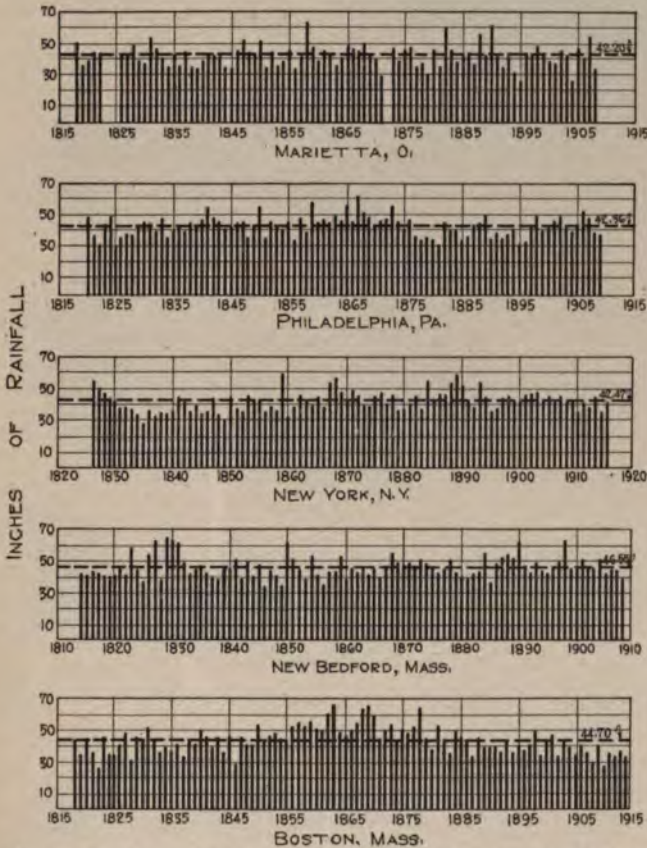

FIG. 7.—Long records of annual rainfall. Dotted line indicates the normal rainfall.

River Gage Heights.—Although the greatest gage height does not always accompany the greatest flow upon a particular stream, yet the gage height serves very well for a general comparison of the magnitude of floods present and past. It is important to bear in mind, however, that the rate of flow is not directly proportionate to the height of gage.

RELIEF FROM FLOODS

We present herewith Fig. 8 which shows diagrammatically the greatest recorded gage heights upon four of our important streams where records are available, covering a long period. It is not possible to secure the gage heights for every year. In the early years particularly only the

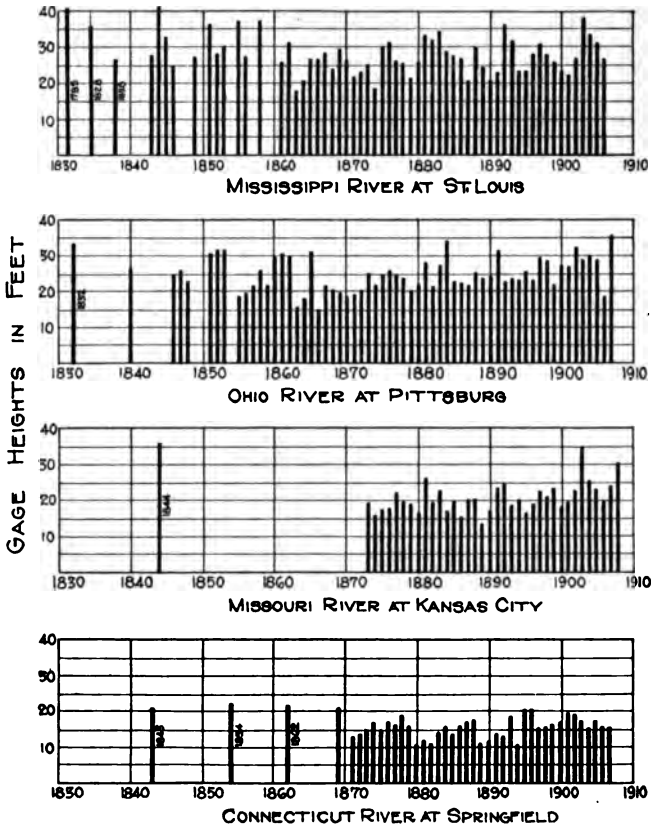

FIG. 8.—Long records of maximum annual high water.

important floods have been recorded. These diagrams are based upon figures presented by Col. H. M. Chittenden.¹

It will be observed that the two greatest floods upon the Mississippi occurred in 1844 and 1785. The extreme gage heights of those 2 years have not been closely approached.

¹ *Transactions, American Society of Civil Engineers*, vol. 62, p. 258.

At Pittsburgh upon the Ohio, the greatest recorded height appears in 1907, but the floods second and third in magnitude were in 1832 and 1816 respectively. Upon the Missouri River the flood of 1844 appears not to have been closely approached except in 1903. The greatest floods upon the Connecticut River appear to have preceded 1870.

Other records are available upon the Ohio River at numerous places below Pittsburgh. At Cincinnati the flood of 1883 was the greatest flood up to that time since the river had been known to the white man. The following year a slightly greater flood occurred which has not been equaled since. At Cairo on the same river the record flood occurred in 1883. It was slightly exceeded in 1912, and again exceeded in 1913.

The late Mr. Emil Kuichling, C. E., quotes the official investigation into the floods of the Seine River at Paris and states that in observations covering 400 years the greatest flood occurred March 1, 1658. The flood second in magnitude occurred Jan. 28, 1910. This flood almost equaled the great flood. The flood third in magnitude occurred Dec. 26, 1740; it was slightly smaller than the flood last above mentioned.

Mr. Kuichling also quotes experience on the River Danube at Vienna, on which the highest water from well-attested flood marks occurred in the year 1501. The flood was roughly estimated at 503,200 second-feet on 39,200 square miles. Numerous floods have since occurred upon this river, but none larger than 307,800 second-feet.

It cannot be said that the above citations indicate any important tendency either for the increase or decrease of floods. The records are important, however, as emphasizing the value of long records and the chance for serious error in the drawing of conclusions from records covering only short periods.

Flood and Runoff Studies.—During the past 10 years a number of studies have been made for the purpose of determining whether prevailing stream flows and floods have

materially changed in the passage of time; more particularly whether the cutting of the forests has resulted in any material change in these respects.

Merrimac River.—A valuable study of the flow of the Merrimac River was made by Lieut.-Col. Edward Burr.¹ This report bears the date of May 23, 1910, and was prepared in response to orders of the Chief of Engineers, U. S. A., for the purpose of determining what influence, if any, the forests exert upon the stream flow of the locality in question. Daily records of stream flow were available at Lawrence from 1849 up to 1909.

Col. Burr compared the runoff of the stream and the rainfall as determined from adjacent stations. A critical examination was made relative to floods, dividing the several years up into the seasonal floods of winter, spring, summer and fall. The floods above certain gage heights were counted; also the number of days the various gage heights prevailed. The low-water record also was scrutinized as to the frequency and duration of extreme stages.

Col. Burr's conclusions are quoted as follows:

“Deforestation of the basin (Merrimac River) continued progressively from the earliest settlements until about 1860 to 1870, and since that period, forested areas have increased through natural causes by 25 per cent. or more of the entire basin, notwithstanding the continuance of lumbering operations.

“There has been no decrease in precipitation in the basin as a result of deforestation, or any increase with the reforestation of 25 per cent. or more of its area. The precipitation for 50 to 90 years at points within the basin or within a few miles of its borders shows tendencies or cycles that bear no relation to the changes in forest areas.

“The average runoff through the river varies with the precipitation over its basin, and the percentage of runoff to precipitation is not appreciably affected by forest changes as great as 25 per cent. or more of the basin.

“The frequency of floods has not been decreased by forestation, or increased by deforestation.

“Exceptionally high floods have occurred at intervals without respect to forest conditions.”

¹ *Document 9, 62d Congress.*

Mead's Wisconsin Studies.—Wisconsin is one of the States most noted for its production of lumber. During the last two generations practically all the merchantable timber in the State has been cut. Prof. Daniel W. Mead¹

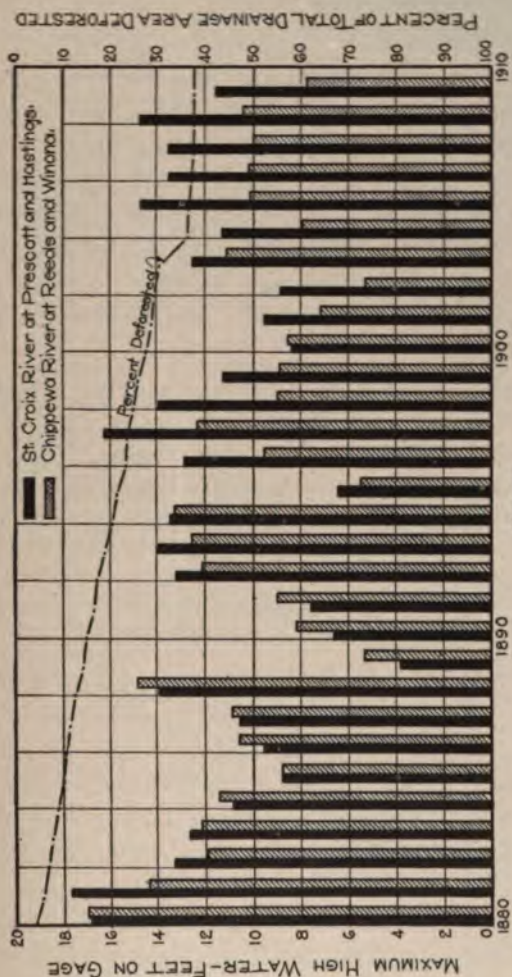

Fig. 9.—Greatest annual flood heights, St. Croix and Chippewa Rivers, and per cent. of areas deforested.

has made an exhaustive study of the available flow records upon the Wisconsin streams, particularly to determine the effect of the forest cutting upon the flow of the streams,

¹ "The Flow of Streams and the Factors that Modify It, with Special Reference to Wisconsin Conditions," *Bulletin 425*, University of Wisconsin.

maximum, minimum and average. Among Prof. Mead's conclusions we will quote the following:

"That in general, the deforestation or cutting of timber in Wisconsin has had no material effect either favorable or adverse, on the high-water, mean-water or low-water flow of the streams or on the regularity of such flow."

The conditions in Wisconsin on the St. Croix and Chippewa Rivers relating to forests and the stream flow are further covered in a paper by C. W. Durham, Principal Assistant, U. S. Engineer.¹ Fig. 9 shows graphically the rapidity of the deforestation upon these watersheds from the first cutting of lumber about 1875, down to 1909. No important change in the high-water conditions is noted from a scrutiny of the records upon these two streams. Mr. Durham concludes:

"My conclusions are that the destruction of the pine forests in Wisconsin has had no effect whatever in creating or increasing floods and drouths in tributary streams, or in the Upper Mississippi, inasmuch as these features are controlled by precipitation which has not increased or decreased to any marked extent, at least not during the periods of accurate observations made by the Weather Bureau. The high waters are not higher, nor the low waters lower than formerly, nor are they of greater frequency and duration, and the tendency appears to be of late years favorable to navigation in both respects."

The investigations of Europeans have frequently been cited to give evidence of the beneficial effect of forests on stream flow. Prof. Willis L. Moore, Chief of the U. S. Weather Bureau, in his report on the "Influences of Forests on Climate and on Floods" refers to the investigations of Mr. Ernest Lauder, Chief of the Hydrographic Bureau of the Austrian Government, who has recently made an exhaustive investigation of the records of the Danube River. These investigations trace the flood history of the Danube for 800 years, and take into account 125 different floods. It is concluded that the progressive deforestation of the country has had no effect in increasing the frequency of the floods or augmenting their height. The report of Prof.

¹ *Engineering News*, June 23, 1913.

Moore also contains a table showing the greatest floods on the River Seine in France since the year 1615 (Table V). The floods of recent years are shown to have been somewhat less than those several centuries ago, although conditions in the several basins are said to have remained substantially the same, excepting the extent of the forests, which have steadily decreased.

Prof. Moore concludes his report as follows:

“1. Any marked climatic changes that may have taken place are of wide extent and not local, are appreciable only when measured in geological periods, and evidence is strong that the cutting away of the forests has had nothing to do with the creating or the augmenting of drouths in any part of the world.

TABLE V.—GREATEST FLOODS UPON THE RIVER SEINE IN THE PAST 300 YEARS

(From Paper by Willis Moore, Chief of U. S. Weather Bureau)

Dates of the inundations	Height at the bridge of La Tournelle, feet
1615, July 11.....	29.99
1649, January.....	25.10
1651, January.....	25.59
1658, March 1.....	28.87
1690, March.....	24.61
1711, March.....	24.77
1740, Dec. 25.....	25.92
1751, January.....	21.98
1764, Nov. 14.....	22.97
1784, March 4.....	21.85
1799, Feb. 4.....	22.87
1802, Jan. 3.....	24.44
1807, March 3.....	21.85
1836, May.....	18.66
1850, February.....	19.91

“2. Precipitation controls forestation, but forestation has little or no effect upon precipitation.

“3. During the period of accurate observations, the amount of precipitation has not increased or decreased to any extent worthy of consideration.

“4. The runoff of our rivers is not materially affected by any other factor than the precipitation.

"5. The high waters are not higher, and the low waters are not lower than formerly. In fact, there appears to be a tendency in late years toward a slightly better low-water flow in summer.

"6. Floods are not of greater frequency or longer duration than formerly."

Basis For Popular Belief.—The popular belief that the flow of the streams becomes more irregular with the cutting of the forests is not by any means new. It was probably originally based upon the impressions of those who occupied farming lands from the time that the forests first began to be cleared away. In some localities these impressions doubtless have more or less basis in fact, but no doubt local impressions have unconsciously been magnified and have been considered to apply to larger areas and to different conditions and thus erroneous impressions have probably been formed. This popular impression it probably not unlike the belief frequently held by elderly people that the old times were the best, that the snows were deeper, and that skating and sleighing came earlier and lasted longer than they do now.

The popular belief has been fostered, particularly within the last 10 years, by several investigations by scientific men, tending to indicate that stream conditions are changing, particularly that the deforestation of the country has produced a change in the regime of the streams. For the most part these data have been presented by those particularly interested in forestry, who have been especially interested in promoting the care and preservation of our present existing forests and the reclamation of our waste lands.

Most of these studies have been based upon a comparison of stream flows in the wooded areas, and that of our particular case, the upper reaches of the St. Lawrence, with areas subjected to logging and other uses, and have, except upon a few occasions, been based upon a comparison of the same stream in the wooded areas with the same stream in the cleared areas. It is not clear, however, that the greater part of the data upon which these studies are based are based upon a comparison of the same stream in the wooded areas with the same stream in the cleared areas.

sented, covers periods of sufficient length to indicate tendencies, even if it is assumed that the forest changes were material during the short periods considered, which has not been proved so far as the writers have observed.

Flood Tendencies Summarized.—Some day it will probably be determined as to how much complete forestation affects the flow of the streams under the ordinary circumstances prevailing in nature. It is doubtful if it can be determined at the present time.

It seems to be clear, however, that reforestation is not a practicable means for the present relief from floods. Enough is known to warrant the statement that the benefit would be small, and moreover, our good lands cannot be spared for growing trees. They are needed for more valuable purposes, and where waste lands are available, if we assume a large benefit from reforestation, the remedy would be too slow of application for the practical flood problems with which the public is now confronted.

So far, therefore, as we have data, no tendency for increased flood magnitude is observable except that with the passage of time the likelihood for that peculiar combination of circumstances that makes for heavy runoff is increased. It is believed, however, that we may look backward in prognostications with assurance that if the backward view is sufficiently long, it will indicate to us the worst that the future probably has in store.

CHAPTER II

VARIOUS MEANS FOR FLOOD RELIEF

In undertaking any public work involving large expenditures for the protection of human life and valuable property, it is quite important that all reasonable remedies should receive such consideration as may be warranted under the local circumstances. Unless all reasonable remedies other than the one that may be adopted shall have received proper consideration, they are very likely to rise up and plague those in charge of the works, even to the detriment and delay or even the defeat of proper works.

In measures for flood relief it is particularly necessary that the whole field of available remedies should be properly canvassed, for this is a subject where local experience has not been sufficiently extensive so that proper lines of procedure can be selected without considerable investigation. It will serve a useful purpose, therefore, to outline the remedies for the flood problem that have proved effective in the past, or that may have been seriously considered by those who have carefully studied the flood problem.

Types of Flood Relief. Works for the relief of floods may be divided into three principal classes, as follows:

(A) **Flood Prevention.** Works for flood prevention include all means for reducing the rate of flood flow. In this class are placed the reservoirs or detention basins for the purpose of storing flood flows and feeding the water gradually to the streams. Reforestation would fall in this class where it can be shown that it would have an influence on flood flow.

Flood Protection.—Works for flood protection do not reduce the flood flows but protect against them. These

works include levees and channel improvements, including channel straightening or enlargement.

(C) **Flood Diversion.**—It sometimes happens that excessive flood flows can temporarily be diverted from the places where harm is done to other places where the flood is less objectionable. This is a remedy that was adopted in some of the ancient works for flood relief, the flood waters being diverted to desert lands. The remedy is applied in this country only to a limited extent.

It will be useful to briefly discuss these remedies for floods in order to determine their applicability, and to enumerate a few of their applications to practical flood problems.

Diversion Works.—Situations in which the flood water can be diverted are very rare in this country, for the reason that nearly all our land is valuable, particularly in localities where values and flood damages warrant measures for flood relief. Although this remedy has been proposed to relieve the flood situation on the Lower Mississippi through the diversion of a part of the flood waters to other streams, there is no application of this remedy upon a large scale. In ancient times this remedy was extensively applied in Asia and Africa. Sir William Willcocks¹ is quoted as follows:

“Ancient Babylonians completely controlled the Euphrates by means of powerful escapes into depressions in the Arabian deserts. These depressions cover 650 square miles and were 25 feet deep when full of water. In addition to these reservoirs, they had the low-lying Pallacopas branch of the Euphrates which took off from above Babylon, and discharged the waters of the river into the Chaldean marshes. The first public work Alexander the Great undertook in Babylon was the excavation of a new head on solid ground for the Pallacopas, known some years ago as the Hindia branch, and today the main stream of the Euphrates. Its head had hitherto been in sandy soil, and as the branch had to be opened in very high floods to escape the excess waters of the Euphrates, and then immediately closed after the flood to keep the main stream full of water past Babylon, the closure had been the work of extraordinary difficulty, entailing the presence of 10,000 men.”

¹ “River Regulation and Control in Antiquity,” address before the National Drainage Congress at Savannah, Ga., April 19, 1914.

A similar form of relief was used upon the River Nile in very ancient times. Sir William Willcocks is again quoted as follows:

“It was Amenemhat of the twelfth dynasty who put the whole Nile Valley under cultivation, constructed the dikes on both banks, and provided the Nile with an escape into the wide and deep depression of Lake Moeris. This escape was one of the seven wonders of the Greek world. They led the flood into the depression when it was dangerously high, and provided for its return to the river when the inundation had come to an end, so that the reservoir might be empty when the next flood came. The gigantic entry and exit dikes were only cut in times of emergency, and were reconstructed again at an expense of labor which even builders of pyramids considered excessive.”

As above stated, the opportunities for flood diversion are not numerous in America. The very excessive floods of the Des Plaines River near Chicago are diverted into the watershed of the Chicago River in order that they may not damage a part of the Chicago Drainage Canal. Prof. C. E. Sherman has suggested the diversion of the waters from the Upper Scioto River in Ohio and the storage of same in reservoirs upon the Upper Sandusky River, the water later to be used for water power upon the Scioto and Sandusky. There are other minor examples of this flood remedy. This remedy is applicable only where cheap land is available, or where the water can be diverted to outlet channels not used to their full capacity.

Protection Works.—The works for flood protection including levees and river-channel improvements are too well known to require lengthy description. The most famous examples are the dikes of Holland which protect that country from the tides. Our levee system upon the Lower Mississippi is probably the greatest work of this kind in the world, and works for flood protection by levees are scattered all over the United States. Large acreages of bottom land are thus protected in the valley of the Illinois and the Upper Mississippi River, and similar works are to be found in nearly every State of the Union.

In general, protection works are of local benefit. They

are ordinarily built by individual cities or local organizations of landowners. Their benefit is confined to the locality immediately protected. In some cases they may be detrimental to adjacent territory, as upon the Illinois

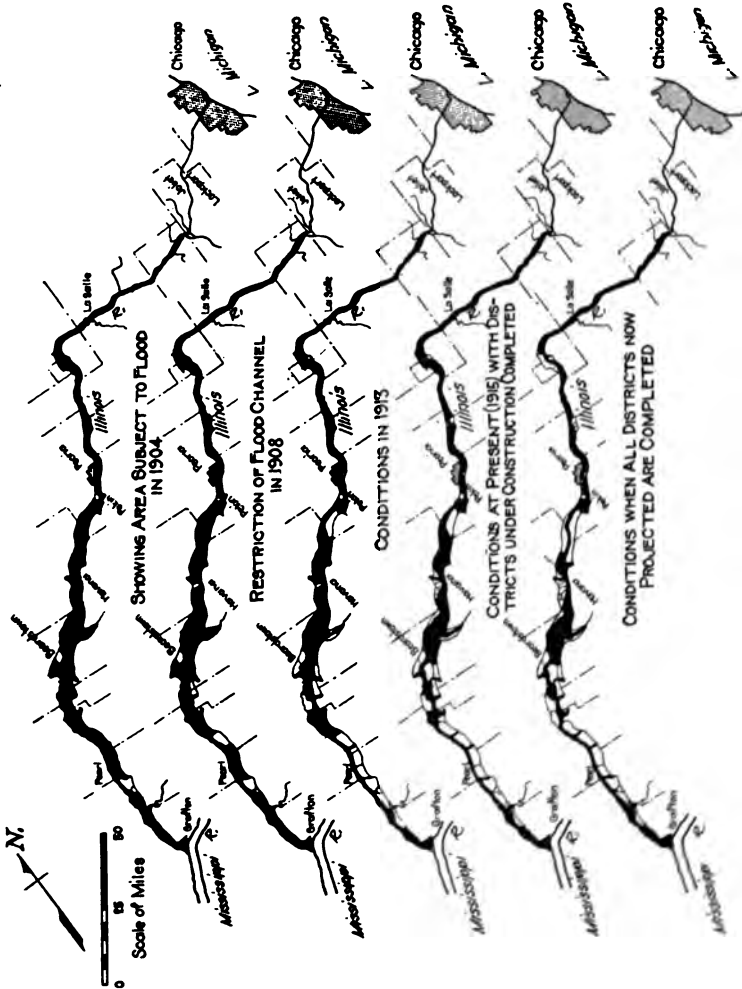

FIG. 10.—Map of Illinois River bottoms showing levee districts. Levee districts upon the lower Illinois River have reduced the width available for flood waters by 80 per cent. and have reduced the cross-sectional area available for floods to 25 per cent. of that which prevailed originally.

River, where farm-land levees so restrict the flood-water cross-section as to cause materially greater flood heights for a given flood flow, and, therefore, submerge land up stream that would otherwise not be submerged. The

reclamation of river flood plains by the construction of levees also has a detrimental tendency in the river-valley storage that is thus destroyed.

In many localities there is no other alternative than the construction of levees. They are usually the only practicable remedy for the relief of a small locality, for often natural conditions permit the protection of a city or the reclamation of a large acreage by comparatively inexpensive levees, whereas only widespread benefits to valuable property can finance the works for flood prevention or flood diversion.

Preventive Works.—Although forestation, provided it can be shown to have an important effect upon floods, would fall in this class of flood-relief works, we have previously pointed out why it is a remedy too slow of application to be of practical use in our present flood problem. It remains, therefore, to consider the preventive works involving water storage.

It is easily comprehended that if detaining reservoirs are provided sufficient in capacity to hold the larger part of the great floods, it would be possible by releasing the water gradually to make the flow of the streams nearly uniform. Knowing the flow of the stream from day to day, and from year to year, it is practicable to compute the amount of storage that would thus be required.

Some of our streams are fed from natural storage reservoirs. The St. Lawrence River is notable for its exceptional regularity of flow. The system of Great Lakes, which feeds it, occupies about one-third of the tributary drainage area, and stores several times the annual flow of the stream. Most people have noted the uniformity of the lake-fed streams. This regularity of flow is equally noticeable in those streams draining the sandy and gravelly country, such as the streams of the lower peninsula of Michigan. In this case the water is absorbed and stored in the porous subsoil, and gradually leaks out in springs and in the stream beds.

Reservoirs for Flood Protection.—It will readily be

appreciated that if a reservoir shall be useful for flood protection, it must be in such a state of emptiness that it may store the flood when it comes. It is impossible to predict far in advance when a flood will occur. Great floods are rare, but may occur at any time. It is usual, however, that they occur in the late winter or early spring. Floods resulting from a given rainfall in the growing season must be less by that part of the rainfall which is retarded and held back through the agency of vegetation and the permeable ground conditions that exist in the growing season.

Although the necessity for reserve flood capacity is evident, basins which store water for any purpose exert a beneficial effect on floods, and this effect is usually important, for the greatest floods usually follow a period of low flow in the winter and fall, and, therefore, the early spring is a time when the storage reservoirs are ordinarily depleted. The growing season begins very soon after the freshets of early spring, after which the rainfall becomes quite moderate and in general natural storage basins will be emptying until the following winter.

Main Purpose of Storage Reservoirs. Although a great many storage reservoirs have been built in the United States, no large detaining basins have been built as far as known primarily for flood protection. There are a large number of reservoirs built for the concentration of municipal water supplies. In the construction of our water-power plants, the streams have been dammed for the purpose of creating head, and the ponds thus created have been used also to store water in time of plenty to be used in drought, or to store water from head to head to be used according to the demand for power.

It will be perceived that there is nothing to prevent the utilization of a storage reservoir for all these purposes providing that it has the necessary capacity at the proper time to accomplish all the purposes for which it is intended, thus, a certain part of the capacity would be used to create head for water power and an additional portion of the

capacity could be used to store water for the creation of power, and a third portion could be used to store flood waters. A part of the stored flood water could be converted into power, but probably not all, for it may be desirable to let the flood waters pass away as quickly as possible in order that the basin may be ready for another flood.

Where heavy property interests are to be protected, and particularly where great loss of life may be involved, nothing must be left to chance. All the chances must be pro-



FIG. 11.—Cleaning the streets after the Dayton flood.

vided against. Therefore, in works for flood protection it is not sufficient to provide against the ordinary occurrence, but the exceptional must also be provided against, and for this reason it is difficult to coordinate a storage reservoir to various uses, which may be at times conflicting. It is practicable, however, to design a reservoir that automatically maintains a water level not less than a certain height, as may be needed for the creation of head in power development, that may fluctuate automatically between the minimum level and a certain higher predetermined level, the position of which may be fixed by a free spillway or outlet; and by properly proportioning the spillway or outlet an additional height may be utilized for flood-water storage. It then would automatically drain away at a rapid

rate over the spillway to the level fixed for the top of stored power water.

The practicability of all these things would depend upon costs and benefits. If adequate flood protection can be secured and if, in addition, water power or water storage can be created at an additional cost that would be warranted by the benefits secured, then such multiple use is warranted and it is theoretically possible under favoring conditions to design works that will accomplish all these purposes.

The use of storage reservoirs for a variety of purposes has been practised on a small scale in Europe. In the United States, reservoirs, so far as known, have been designed for one specific purpose, such as water storage or water power, and the other benefits have been merely incidental. A number of reservoirs have been built for the improvement of navigation, including the reservoir system at the head of the Mississippi River, the greatest artificial reservoir system in the world. These reservoirs were constructed very cheaply by introducing low dams at the outlets of large natural lakes.

Detention Basins.—A detention basin may be defined as a dam across a river valley having in its base an opening of such predetermined size that in the case of a great flood, the water ponds up behind the dam and is re-delivered to the stream only so fast as the opening provided can carry it. Thus, with a detention basin of sufficient size, and an opening sufficiently small, it would be practicable to reduce the flood to any rate desired. This idea is not new, it having been utilized in France since 1711, when two reservoirs of this type were constructed upon the River Loire for the protection of the City of Roanne and the adjacent valley. A number of other detention basins have been built, as will hereinafter be shown in the review of foreign experience. No large detention basins have been built in America, although they are proposed as a remedy for the flood conditions in the Miami Valley in the official plan of the Miami Conservancy District.

Storage vs. Detention Basins.—The decision as to

whether the surplus water shall be drawn away as rapidly as possible, as in a detention basin, or whether it shall be stored and gradually fed for the use of water supply, water power and navigation, is entirely a matter of practicability and cost. If the situation makes possible all these uses, and if the values of such uses are sufficient to warrant the costs involved, then without doubt the storage reservoir should be built.

The pure detention basin, however, finds its place in the situation where flood protection alone is warranted by the circumstances of the case and the costs involved.

EUROPEAN EXPERIENCE

River control is by no means confined to modern times. Practically all methods of flood relief were practised by the ancients, for in the arid countries which seem to have been first occupied by civilization, the distribution of the rainfall is even more unequal than in the temperate zone, and many regions are uninhabitable without artificial works for the conservation of water. Some of the ancient works, more or less modified, are in use today.

In Europe, as in America and in fact in all civilized countries, more or less low land is protected against the effect of floods by the construction of levees. The works of this class are too numerous and too common in this country to require extensive comment. Just now when storage reservoirs are being avidly contemplated for the proposed large expenditures on flood relief in Ohio, reference is frequently made to the reservoirs and sets of levees of low water constructive value which have been lately built, and which have been accomplished at a cost of \$100,000,000.

It is to be recalled that while a very small number of reservoirs were built in the Ohio valley, many of them were never started, and that the cost of their construction was \$100,000,000. **Water storage** for water supply, for navigation, and for power, is the only method of flood relief which has been performed in such cases.

French Experience.—Of the modern European nations, the French seem to have been first to construct extensive water-storage works for flood protection. In 1711 two dams were constructed upon the River Loire, that embody all the essential principles of the dry reservoirs or detention basins that are being proposed for flood protection in Ohio. These are masonry dams 72 and 87 feet in maximum height, respectively, which contract the flood plain of the river, and in the case of extreme floods, require the flow to pass through a narrow opening in the channel of the stream 65 to 70 feet in width.

The head created at these dams is only material during a great flood. Thus, in 1846, the head created at the Pinay Dam was 9.5 feet, and at the La Roche Dam, 19.7 feet. This refers to the differences in water levels above and below the dams. The beneficial effects of these reservoirs led to the appointment of a government commission in 1856, which carefully studied the flood situation upon the Rhone, Garonne and Loire Rivers.

Although France was the pioneer in the modern European water studies, the French works for flood-water storage are not extensive. Table VI shows the data of six storage dams, including the two already mentioned.

German and Austrian Experience.—Although the construction of artificial works for river control has been practiced in Germany since the fifteenth century, this work has been particularly extensive since 1900. In Germany and Austria more than fifty reservoirs have been constructed, and two or three times as many more are projected.

Through the coöperation of the government and the interests along certain streams, comprehensive programs have been laid out embodying the construction of reservoirs to catch flood water, and in many cases to use the water thus retained for water supply, water power, the improvement of low-water conditions in the streams, and for the supply of navigation canals. In some cases coöperation is extended across the national boundary line between

RELIEF FROM FLOODS

TABLE VI.—TABULAR DATA OF EUROPEAN STORAGE RESERVOIRS
 Abstracted from Report of Pittsburgh Flood Commission and Paper by Kenneth C. Grant

Reservoir	River	Dam		Capacity		Cost per acre-foot dollars	Drainage area square miles	Date built	Remarks
		Masonry or earth	Height feet	Million cubic feet	Acres feet				
FRANCE:									
Pinay.....	Loire	M	72.0	3,530.0	81,000	1711	Automatic detention reservoir.
La Roche.....	Loire	M	86.7	1711	Automatic detention reservoir.
Furens.....	Turens	M	184.0	56.5	1,300	244.00	1862	Flood protection and water supply.
Ternay.....	Ternay	M	119.0	91.8	2,100	97.00	1865	Flood protection and water supply.
Riom.....	Var	M	130.0
Roanne.....	Loire	M	177.0	159.0	3,700	10 per cent. reserved for flood water.
GERMANY:									
Bever Valley.....	Wupper	52.5	116.5	2,670	128.00	9.0	1898	15 per cent. reserved for floods } 6 other dams
Lingese Valley.....	Lingese	92.0	2,120	122.00	4.0	1900	4 per cent. reserved for floods } on this river
12 reservoirs.....	Trib. of Ruhr	M	64-114	1,447.0	33,500	104.00	1894-1910	Flood storage used for water supply and power.
Urf.....	Rur	M	190.0	1,608.0	37,000	27.00	145.0	1901-4
No. 1.....	Weiserits	M	119.0	310.0	7,150	Principally for floods.
No. 2.....	Weiserits	M	131.0	547.0	12,600	Principally for floods.
Malter.....	Red Weiserits	M	115.0	309.0	7,100	124.00	40.0	* Built since 1897.
Klingenberg.....	Wild Weiserits	M	128.0	536.0	12,300	70.00	35.0	* Built since 1897.
Eder.....	Weiser	M	136.0	7,145.0	164,000	27.50	552.0	* Probably completed in 1913. Canal feeder.
Oder.....	Oder	M	170.0	780.0	18,000	81.00	1906

TABLE VI—(Continued)

Reservoir	River	Dam		Capacity		Cost per acre-foot dollars	Drainage area square miles	Date built	Remarks
		Masonry or earth	Height feet	Million cubic feet	Acre-foot				
Arnoldsdorf	Goldbach	E	70.4	1,810	\$ 65.00	1906	
Wölfel	Wölfelsbach	M	98.0	32.1	740	168.00	10.0	1905-8	
Seitenberg	Glastzer Neise	E	40.5	930	73.00	1905-8	
Schman	Steinbach	E	56.4	1,300	69.00	1907	
Klein Waltersdorf	E	16.9	390	102.00		
Buchwald	Bober	M	48.0	77.7	1,770	148.00	23.0	
Grusau	Bober	E	28.1	640	134.00	1903-6	
Zillerthal	E	105.8	2,400	114.00	1909	
Herrschdorf	Heidewasser	E	27.5	141.2	3,250	67.00	36.0	1903-6	
Warnbrunn	E	23.0	212.0	4,900	78.00	46.0	1906-8	
Mauer	Bober	M	196.0	1,765.0	40,500	44.00	467.0	1905	
Friedberg	E	37.0	120.2	2,750	43.00	24.0	1908	
Marklissa	Queise	M	141.0	529.5	12,100	74.00	118.0	1901-4	
Austria									
Hatsdorf	Göhltaer Neise	M	62.0	22.2	510	324.00	6.0	1902-4	
Fischschwald	Göhltaer Neise	M	92.0	70.6	1,600	225.00	1.6	1902-6	36 per cent. for floods.
Angtalbach	Göhltaer Neise	M	82.0	8.9	202	465.00	2.7	1904-6	50 per cent. for floods.
Mühlbach	Göhltaer Neise	M	72.0	8.9	202	610.00	2.6	1904-6	
Görsbach	Göhltaer Neise	M	70.5	17.7	405	510.00	4.6	50 per cent. for floods. Not complete when reported.
Grünwald	Göhltaer Neise	M	65.6	95.3	2,180	248.00	10.3	1906-8	
Königsruhe-Walde	Elbe	M	136.0	320.9	7,300	132.00	200.0	
Spundmühle	Elbe	M	136.0	119.5	2,730	240.00	22.4	83 per cent. for floods } Under construction in
Hlnako	Chrudimka	E	40.0	81.2	1,860	80.00	21.6	89 per cent. for floods } 1911.
Parov	Doubravka	M	101.0	60.0	1,380	217.00	80.7	75 per cent. for floods
Six reservoirs	Wien	M	56.5	1,280	1,310.00	86.0	1895-6	Protects city of Vienna.

Proposed Reservoirs. 1 large reservoir on the Weiser, 13 planned on the Oder, 8 on the Elbe Watershed, and others.

Germany and Austria. The Austrian reservoirs now constructed are almost as extensive as those in Germany.

Table VI shows the principal details of German, French and Austrian storage reservoirs. These data were largely abstracted from the report of the Pittsburgh Flood Commission, supplemented by additional information in a paper read before the Ohio Engineering Society, by Mr. Kenneth C. Grant. It will be observed that, although these dams are many of them quite high, the highest being nearly 200 feet, the volume of water stored is very small as compared to the dams now proposed in the Miami Valley and for the Scioto Valley in Ohio.

Other Countries.—The largest artificial storage reservoirs in Europe have been constructed in Russia for the control of the Volga and Meta Rivers. These reservoirs are similar to those in the Upper Mississippi in America, in that they are natural lakes artificially increased in capacity by the construction of dams. The total capacity of these reservoirs is about 35,000 million cubic feet. This is equivalent to 940,000 acre-feet.

In Spain, although the rainfall is light, flood damage is considerable in certain places. Four reservoirs have been constructed created by dams from 100 to 134 feet in height and eight more are planned. These works serve the double purpose of flood control and irrigation.

FLOOD RELIEF IN AMERICA

The greatest American flood problem is the protection of the overflow lands in the valley of the Mississippi River between Cairo and the Gulf.

Lower Mississippi. The situation in this valley is described by General Chittenden as follows:

Within the framework of the flood plain there is an area of about 30,000 square miles which, practically, is susceptible to reclamation has been estimated at 10,000 square miles or 25,000,000 acres. An average future valuation of \$100 per acre gives \$2,500,000,000. A future

Flood Control. By H. M. Chittenden, as reported to the Inter-Engineering Congress, San Francisco, Cal., Sept. 20, 1915.

population of 300 to the square mile gives 7,500,000. The mileage of railways crossing this area in all directions, forming parts of interstate systems, is already large and is constantly increasing. The possibility of the development of an empire here greater than the Belgium or Holland of today is absolutely dependent upon protection from the river."

Works for the reclamation of these bottoms have been more or less steadily pursued since 1727. The expenditures for levee construction have been approximately as follows:

Prior to the Civil War, expenditures by private enterprises.....	\$41,000,000
Expenditures by private enterprises since the Civil War about.....	70,000,000
Appropriations by Federal Government between 1879 and 1912 about.....	<u>77,000,000</u>
Total about.....	\$188,000,000

At the present time all the river front is leveed except where the valleys are too narrow to warrant levee construction. Of the total length of 1,570 miles requiring levees 1,500 miles has been built. Although most of the bottom-land frontage is protected, many of the levees are of insufficient height to adequately protect the lands against floods that have occurred in the past and are likely to occur again. It is estimated that the cubic contents of the present levees up to the year 1914 was about 275,000,000 yards and that the levee system as a whole may be regarded as about 60 per cent. completed.

General Chittenden is quoted as follows, relative to the future plans for the river:

"As was natural, the magnitude and the importance of the problem have suggested many solutions, reforestation, cutoffs, bipsases, outlets, and levees, but all (if we except a possible outlet near New Orleans) have been rejected except the last. There has been a vast amount of discussion during the past 75 years, but the above conclusion is stronger today than ever among well-informed engineers, and the problem will apparently be worked out on a 'levees only' basis."

Mississippi Reservoir System.—The most capacious reservoirs in this country are those constructed on the headwaters of the Mississippi River for the purpose of storing flood waters and replenishing the low-water stages. These reservoirs are formed by dams across the outlets of natural lakes. The primary purpose of this work was to aid navigation, but it has been found to diminish the floods and to benefit the water power and lumber interests. This work was begun in 1881 and finished in 1886, at a total cost of \$1,953,049.53. Six reservoirs were built as follows:

TABLE VII

Reservoir	Head in feet	Storage capacity	
		Billion cubic feet	Acre-feet
Lake Winnibigoshish.....	14.2	44	1,000,000
Leech Lake.....	5.7	33	760,000
Pokegama Lake.....	12.0	5	116,000
Sandy Lake.....	11.0	3	69,000
Pine River.....	18.5	8	184,000
Gull Lake.....	3.0	3	69,000
		96	2,198,000

These reservoirs have been effective in improving the low-water stage in St. Paul by the amount of 14 inches. St. Paul is 413 miles below the uppermost reservoir, and 168 miles below the lowest. The river is beneficially affected as far south as Lake Pepin.

Ottawa River Project.—There is now under construction a large water-storage system upon the Ottawa River in Canada. The reservoirs are formed by dams built across the mouths of the existing lakes. Three projects are now under construction which will impound 3,850,000 acre-feet at the small cost of \$728,000. It is the object of this work to improve navigation, water power and domestic water

Pittsburgh.—The floods on the Ohio, Allegheny and Monongahela Rivers at Pittsburgh have been particularly destructive. A very thorough study has been made of the flood situation at Pittsburgh (Report of the Flood Commission, Pittsburgh, Pa., 1911).

This study resulted in a recommendation of reservoirs for the relief of flood conditions at an estimated cost of \$20,000,000. The future flood loss at Pittsburgh is estimated at about \$2,000,000 per annum. Table VIII shows the principal details of the recommended reservoirs.



FIG. 12.—Flood debris in residential Dayton.

Other Flood Problems.—In Chapter VII will be found a description of the detention basin and channel improvements proposed for the protection of Dayton and the Miami Valley and also the works designed for the protection of the City of Columbus and the Scioto and Olentangy Valley. These larger problems involve the largest expenditures of any other flood-relief measures that have progressed to the stage of general plans.

At Sacramento and Los Angeles, Cal., extensive flood-relief measures are being earnestly studied and permanent works for the control of the Lower Colorado River remain to be planned and built. Practical examples

RELIEF FROM FLOODS

TABLE VIII.—TABULAR DATA OF 17 PROPOSED RESERVOIRS, REPORT OF PITTSBURGH FLOOD COMMISSION

Reservoir	Watershed, square miles	Height of dam* feet	Length of dam feet	Capacity		Cost†	
				Million cu. ft.	Acre-feet	Per million cu. ft.	Per acre-foot
ALLEGHENY WATERSHED:							
Loyalhanna.....	277	122	1,370	4,112.5	94,500	\$297	\$12.90
Black Lick.....	414	63	1,330	1,454.7	33,400	495	21.50
Crooked.....	287	94	1,100	3,255.7	74,600	274	11.90
Mahoning No. 2.....	335	143	740	2,367.8	54,400	460	20.00
Clarion No. 1.....	1,212	142	880	5,067.1	116,500	258	11.20
Clarion No. 3.....		128	800	4,886.6	112,000	210	9.14
Clarion No. 4.....		70	880	1,537.9	35,300	294	12.80
French.....	1,009	75	1,550	3,323.1	76,500	719	31.30
N. Branch French.....	217	67	1,015	2,125.7	48,900	340	14.80
Tionesta.....	477	103	800	3,029.6	83,500	375	16.30
Allegheny No. 1.....	3,795	63	810	2,876.3	66,000	424	18.40
Allegheny No. 2.....		66	1,670	4,877.9	112,000	627	27.20
Allegheny No. 3.....		54	1,415	2,663.6	61,200	520	22.60
MONONGAHELA WATERSHED:							
Youghiogheny No. 2.....	394	76	1,270	1,547.1	35,600	646	28.10
Cheat No. 1.....	1,339	113	1,040	5,737.4	132,000	224	9.73
Cheat No. 2.....		130	1,130	7,294.1	168,000	236	10.30
West Fork.....	366	66	750	2,724.3	62,500	298	12.90
Totals and averages.....	10,182	93	1,091	59,481.4	1,365,000	\$364	\$15.90

*All dams of masonry except one.

† Cost includes land. Average cost of land, \$38 per acre.

applying the principles brought out in this chapter may be multiplied indefinitely in the description of the smaller works for flood relief in this country. Their study, however, would but serve to emphasize the truth that there is a place for almost all the remedies that have been above mentioned and the best procedure in any given case can seldom be determined until a number of the most favorable remedies for that particular situation have been given proper consideration.

CHAPTER III

FLOOD INVESTIGATIONS

Immediately following a great flood disaster, the demand is insistent for immediate relief, and though all thoughtful people will realize if they stop to think, that before construction work can begin, a well-defined plan must be matured, the public is inclined to overlook this necessity, or if it concedes that investigation is wise, its patience is exhausted after a few weeks unless it is shown that a proper amount of investigation and study is necessary.

Before the general public can properly comprehend what is required to mature a comprehensive plan, they must be instructed by the leaders of thought in the community, particularly the newspapers, and it is with the hope that this task may be made easier, that the following pages are written.

Stages of a Public Work.—As Prof. Frederick H. Newell has well said, any large public undertaking necessarily passes through three phases or stages of development: first, the *investigation stage*, second, the *education stage*, and third, the *construction stage*. Minor undertakings are often carried through with an inadequate consideration of the first two stages, but large and important undertakings, works that vitally affect the public, must necessarily pass through these three phases if they will be successful. The first, or investigation stage, may be neglected, or it may be inadequate. This is sometimes the case, but rightly or wrongly, the public must be educated before a large and important undertaking can reach the stage where the “dirt begins to fly.”

Upon the pages which follow, and in the following chapter, it will be our endeavor to enumerate the lines of

investigation that can profitably be pursued in the preliminary stages of a great public work, particularly in projects for relief from floods. The thoroughness with which this investigation is made, and the effectiveness with which the result of the investigation is presented, will largely govern the speed of public education.

Assuming, however, that the investigation has been properly made and properly presented, the mistake is frequently made to assume that the public will educate itself, or that it will blindly follow the lead of public officers. No more vital error can be made, providing that the enterprise closely affects the public interests, and particularly the public pocketbook.

Although the task of public education is not an engineering problem, and can usually be accomplished better by influential laymen than by engineers, yet all the facts and most of the arguments are engineering matters when the works relate to flood relief, and the engineer must furnish the data and be the instructor of the public officials and editors who come most closely into contact with the people.

It usually happens that he who is most conversant with the facts is the best advocate, and for this reason the engineer frequently becomes the most valuable instrument in the education of the public. However, regardless of the facts, to bring the public to one way of thinking is a problem of no mean proportions, as our statesmen are amply able to testify. If the engineer so conducts his investigation that the proper remedy is found, and so presents his findings that most impartial and reasonable people are convinced, he has furnished the basis for public education, and he can consider his duty well done.

Psychology of Reporting.—Many individuals, in fact it may be said that most individuals, will blindly follow advice where they have perfect confidence in the wisdom of the advisor. This is particularly true in such matters as law and medicine, where unaided the individual is hopelessly lost. This is by no means true, however, in public

works. The public has only recently come to a realization of the value of engineering advice, and most of the public problems have heretofore been instigated and investigated by the laymen. In consequence, many people consider themselves quite competent to decide large engineering questions. Were it not for the fact that no two of these offhand remedies are found to agree, many ill-advised undertakings would be carried out. The multitude of suggestions, however, that come after a public calamity makes it almost necessary that the public officers shall seek the aid of someone competent to sift the wheat from the chaff, and formulate a policy or plan capable of being defended.

He whose ground is secure will find it advantageous in dealing with the public to take the public fully into his confidence. Many capable engineers lack the ability or fail to see the necessity of accompanying recommendations with a very full enumeration of the reasons governing the same. A long experience in public work has led to the belief that in the investigation and report upon an important enterprise it is the part of wisdom to fully set forth all the facts and the principal data that bears upon the problem in hand, to outline in considerable detail all the remedies that are reasonably applicable to the problem, particularly including the more important of the remedies that may have been suggested by local people, to compare all the reasonable means of bringing about that which is desired, both as regards adaptability and cost, and to compare the costs, taking into consideration investment, interest upon the moneys invested, depreciation and operating expenses, all in such a way that any well-informed person shall be able to determine the relative merits of the practicable remedies, and can see for himself which is the best, and why it is the best.

In short, it is the engineer's duty to so investigate the matter in hand and so to present it in his report, that the public is substantially in the same position as the engineer to determine what is best. It is only by thus freeing an engineering problem from technicalities that the greatest

value from an engineering investigation can be secured, and when this is properly done the task of public education is more than half completed. The engineering report should be the groundwork of the educational campaign. It should be a campaign text-book, so to speak.

Some very able engineers make the mistake after a course of action has been determined, to present their recommendation in the form of an argument, much as an attorney would present a case at law. Such a presentation will present the recommended solution for the problem in its most favorable light, minimizing all the objections to it, or omitting to mention them, at the same time enlarging upon the advantages of the particular course of action that is recommended.

To follow this procedure is unfair to the public, and in the long run lacks the convincing force of a clear and fair statement of all available means, and a fair and non-argumentative statement of all advantages and disadvantages. The public is very human; it follows easily and willingly if it can see why, but it is suspicious of half-truths and of facts withheld. It is quick to recognize an advocate. The thoughtful public always wants to know the other side.

The general public is a complex body and is made up of all kinds of individuals actuated by various influences. It is only the leaders and the more literary of the citizens who will carefully read and digest a lengthy engineering report. Even these leaders are inclined to lean upon the opinion of certain of their intimates more competent perhaps to interpret the more or less complicated problems particularly relating to flood relief. For this reason the effective engineering report speaks not only to the general public, but it must address the engineering public as well, and while the problem should be freed from technicalities in so far as possible, it is often necessary to go more or less into technical details to convince the engineering public, and particularly to lay all the cards on the table by presenting all data bearing upon the problem in such a way

that the engineering public can form its own opinion as to reasonableness of the recommendations. Most large communities contain several influential and public-spirited engineers, perhaps devoted to some specialty remote from flood relief, but capable of recognizing a meritorious piece of engineering work, and each through his own circle of influence exercising an important influence in helping to bring the public to a right decision.

Conservatism.—The experienced engineer is naturally conservative. Lengthy experience becomes cautious and even skeptical. It is true that the public complains bitterly of expense, and the engineer is sometimes unwisely cajoled into endorsement of projects that are experimental or problematical. The experienced engineer, however, will look ahead, and will recognize the probable consequence of a speculative undertaking. Although cost may seem everything at the moment, yet, after all, the public depends upon the engineer for works absolutely free from the germ of failure, and where the line between success and failure cannot be definitely fixed, and it cannot be in most engineering undertakings, the wise engineer will leave a margin between success and failure sufficiently wide so that by no reasonable chance can the enterprise go upon the rocks.

The structural engineer may know that the average bar of steel will sustain a load of 60,000 pounds to the square inch, but in designing a steel structure he probably will not stress the steel beyond 15,000 pounds per square inch. The concrete designer knows that average concrete will stand a tensile stress of from 100 to 150 pounds per square inch, and yet in designing his structure, he will probably place no dependence upon the tensile strength at all. He knows that sometimes concrete will crack, and its tensile strength will be destroyed.

This margin between ultimate strength and practicable working strength termed "factor of safety" is commonly applied in many forms of engineering design and by no means should it be neglected in the construction of works

for flood relief, particularly where the consequences of disaster vitally concerns human life and heavy property interests.

Selecting the Best Project.—Other things being equal, that project will be best which accomplishes the desired purpose at the least annual expenditure, taking into account a reasonable rental value for the moneys invested, a proper allowance for depreciation and allowances for expenses of operation, if any. To this end the various projects which are considered should be worked out in such detail as may be required to place them all upon the same basis of service, in so far as this is possible; otherwise they cannot be correctly compared, for in complicated engineering problems it very frequently happens that the difficulties of a particular procedure are not clearly seen until plans have been worked out in considerable detail.

With the completion of cost estimates, certain projects may be eliminated at once. A total in dollars is often much more convincing than the most lengthy argument, and a detailed estimate of cost has disposed of many an unwise project in a way that a long line of argument could not do. If the details are reasonable they will probably serve to substantiate a total that would not be convincing without the details.

When the estimates have been completed and the columns have been footed, the investigator then approaches the critical stage in the determination of a future policy. Having done the best which it is possible to do with the figures, he is a wise engineer who will for the moment lay the figures aside and reflect whether after all the remedies compared are equal in point of service. It will almost always be found that some of them possess inherent advantages that are sufficient to outweigh slight differences in cost. Thus, if the annual costs of two projects are substantially the same, the one that requires the least initial outlay is most worthy of consideration, and it often happens that when a limited amount of funds are available, the desired relief can be met only by selecting a project with a

low initial cost, even at the expense of a higher annual cost than would be possible should some more costly project be carried out.

Other things being equal, that project is best that most nearly fits with popular ideas. Leaders of thought should not attempt to controvert popular public opinion unless something is to be gained by so doing. Thus, at Columbus, Ohio, in recommending channel improvements for the protection of the city alone, as distinguished from protection by reservoirs, it was concluded:

“As between reservoir projects built by Columbus for its own protection, and channel improvements of equal cost, we favor channel improvements as being the more simple and reassuring method to the public directly concerned.”

In many respects the common way of doing things is the best way, and a new or novel procedure can be justified only by material advantages such as greatly reduced cost or increased benefits.

In so far as possible, however, the differences in effectiveness should be eliminated in the outline of the projects upon which estimates are made, where the service would seem to be less, and where the uncertainties would seem to be more, it is fair to add additional safeguards and include their cost in the estimated totals. It usually happens when this has been carefully done, that the cost estimates point quite clearly to the project that is most desirable.

Financial Practicability.—When the best remedy has been determined, and its cost has been estimated, the project cannot be successfully urged for adoption unless the expenditures involved are warranted by the benefits to be secured, and in weighing the benefits the ability of the benefited property to pay must not be overlooked. Thus, in a private undertaking, backed by a sufficient reservoir of capital, large future profits often warrant heavy present expenditures, but in public undertakings, present assessments for benefits must not exceed the ability of the property to pay regardless of future benefits.

In measures for flood relief, a remedy becomes practicable only if it can be shown that the expenditure to be made is warranted first, in the light of the value of the property to be benefited, and second, by the probable flood loss of the future. The task of the engineer is not done until it is shown that the recommended project not only is the best one, all things considered, that can be selected, but that it is reasonably warranted under the values and flood losses likely to prevail.

Halfway Measures.—In planning works for flood relief, it usually happens when a project has been carefully considered, that the expenditures involved for its accomplishment look large. Perhaps they may seem beyond the ability of the community to pay. Under these circumstances, the temptation is great to adopt some circum-measure upon the theory that almost any expenditure will improve the conditions, and, therefore, will be warranted. There are situations in which partial protection may be wise. There are other situations, however, in which anything less than complete protection not only is unwise, but may be a menace to the lives and property which it is intended to protect.

A large amount of channel improvement through levees and cutoffs is undertaken for the protection of agricultural land. In some situations as upon the Illinois River, the lands are not largely used as a place of residence, the farmers generally utilizing the building sites above the flood plain. In this situation something less than complete protection can be justified, providing that it can be shown that partial protection will secure the greatest net annual returns, taking into consideration the value of the crops, the crop losses, the maintenance of the flood-protection system, and the interest and depreciation upon investments necessary for flood protection. In situations similar to these, it may be shown that it would be better finance to protect against a flood likely to come, say, in ten years, and stand an occasional crop loss and repairs to the levees, rather than to pay the

fixed charges upon a system of works that would give complete protection.

Successful protection must, however, fulfil the further requirement that an inundation shall not destroy the ability of rehabilitation, that is to say, if a farmer or a farmer's organization would be bankrupt by the loss of a crop or the partial loss of his levee system, then partial protection would be unwise. The test of partial protection is the ability of the owner to insure himself.

Partial Protection of Cities.—In the protection of large districts, as for instance the low lands of Holland, or in the protection of cities where the failure of protective works would mean the sacrifice of human life with enormous property losses, partial protective measures may be worse than none. If the low lands of the city are not protected at all, the worst that can happen is a periodical wetting. Valuable property and perishable property is removed from the flood zone with each inundation, and the most valuable property permanently seeks the high ground. With the construction of protective works, however, the situation is changed in that if the works prove inadequate, the failure is likely to come suddenly, thus not only wetting the flooded district, but creating destructive water velocities, which, rushing upon the unsuspecting inhabitants, may cause great loss of life.

Partial protection was responsible for the disasters at Dayton and at Columbus, Ohio. Without the low levees which were thought to furnish protection, the damage would have been confined to a wetting. The flood would have risen comparatively slowly, and the people would have had time to escape or could have remained in their houses with safety. At both places it was the sudden and unexpected breaking of inadequate levees that caused the great loss of life and the heavy property damage.

At Columbus the 1913 flood is estimated to have reached a maximum rate of about 140,000 second-feet. The leveed channel in the city was capable of carrying about 50,000 second-feet when brim-full. The consequences were in-

evitable. The suggestion has been entertained seriously to enlarge the Scioto channel in Columbus to a safe capacity of about 60,000 second-feet at an expenditure of about \$3,500,000, notwithstanding the fact that there have been two floods within the past 21 years that exceeded this capacity figure. When works are concerned intended to protect a large population, a halfway measure is nothing less than a death trap. Anything less than to adequately protect a place of human habitation is worse than no protection at all, for it creates a false sense of security and multiplies the consequences of failure.

CHAPTER IV

FUNDAMENTAL DATA

Engineering is an old profession comparatively but it is a profession which is unknown and little understood by the public, and people realize only vaguely the process through which an engineering conclusion is reached. An opinion on most problems in medicine, and many of the problems in law may be reached after a very brief inquiry into the facts. In many engineering problems, however, in fact nearly all the problems regarding flood relief, the fundamental facts are extremely difficult to secure, or rather, they can be secured only through a more or less laborious search.

Likewise, in medicine and law, many problems can be decided offhand on the basis of past experience when once the facts are known, but the problems in flood relief are so large, involve so much territory in the construction of the necessary works and require so much time, that no engineer lives long enough to become conversant with all the phases of flood relief in such detail as would be required to reach a correct conclusion from a cursory study of a given set of conditions, even if the human mind were capable of quickly grasping the multitude of facts that bear upon every flood problem of considerable scope.

The engineer is no wizard, and is in no sense gifted with second sight. The best that he can do is to utilize his experience in laying down those lines of investigation that will bring out the required facts with the least possible labor, and to utilize the facts thus obtained in the definition of applicable remedies and the selection of the best remedy through the general process of reasoning that has

been described in the preceding chapter. It is the purpose of this chapter to acquaint the reader with the general line of procedure that should be followed in the investigation stage of any public undertaking for flood relief.

A flood investigation may be divided into three principal phases: first, investigation relating to values and flood losses. It is only by these figures that flood protection can be justified and the practicability of remedies determined. Second, investigations relating to physiography, that is to say, topographic maps and plats that sufficiently define the physical conditions to be met in so far as may be required to compute flood heights, quantities and estimates of costs. Third, investigations relating to hydrology which will include all the facts bearing upon climate, rainfall, stream flows or flood waves, in so far as these facts are pertinent. These investigations may be, and usually are, carried on simultaneously. It sometimes happens that the values to be protected, and the flood losses, or possibly great loss of life, makes it unnecessary to go very deeply into these financial statistics. Upon the other hand, projects for flood relief are usually large and costly projects, and even if the benefits obviously exceed the cost involved, it serves to clarify the argument very much to show at least, approximately, the degree of excess.

Investigations Relating to Values and Losses.—The tax returns usually furnish the best guide to value. It is often necessary, however, to enter the taxable values upon a plat in order to separate values that are benefited from those that are not. Where the investigation involves city property, it is very convenient to plat the value of land and improvements upon each lot, or if the acreage considered is very large, acre values may be platted upon each block. Where agricultural land is involved, it is convenient to plat acre values with improvements upon each farm.

In most localities assessed valuation is materially less than full value. Where this is the case, it will be necessary to multiply the assessed values by such factor as may be necessary to ascertain true values, for the reason that dif-

ferent classes of property are not assessed upon the same basis, and after all it is true value rather than assessed value, that will govern practicable expenditures for relief.

A convenient method to reach the true value of farm land is to plat transfers upon the plat showing assessed values, and in this way to determine a reasonable ratio between assessed value and true value. In the absence of recent transfers, properly distributed, and this applies particularly to city property, it will be necessary to consult the best-informed local residents.

There are certain other classes of property, including such municipal property as streets, street pavements and sidewalks, also public utility property such as water, gas, electricity and transportation that must be valued in the light of expenditures, which are a matter of record, values for the purpose of taxation if the values are known to be full and fair, as they are in some States, or in most cases it is necessary to prepare estimates, being careful not to involve details of greater refinement than are warranted in a preliminary investigation.

In the investigation at Columbus, Ohio, the full values and losses were investigated, and totals were determined with such accuracy as was thought to be necessary for a general report. To the value of the land and the buildings in the flood zone there was added the value and damage to such municipal property as the city water works, storage dam, pumping station and purification works, city pipe system, the municipal sewerage system including the sewage-disposal plant, the street improvements, including pavements and sidewalks, the city bridges and viaducts, municipal lighting plant with its distribution conduits, and to this was added the value and damages sustained by the city schools, fire department, the city workhouse, the garbage-reduction plant and the municipal levees. The county property was considered, including the county bridges, as well as the State property. Allowances were also made covering steam railway property, street railways, telephone and telegraph companies, gas company,

church property, manufacturing industries, retailers' stock and fixtures, merchandise in transit, and such personal property as was contained in the homes. To the flood losses were also added items of expenditure involved in the rehabilitation of all these things, where damaged by the flood, including the funds necessarily spent for flood relief.

In projects of larger scope, including rural territory as well as municipal property, there are other classes of values and losses that must be introduced. In the Ohio floods a



FIG. 13.—Stones deposited where the current slackened below a place of heavy wash.

large amount of farm land was ruined through the removal of the soil by washing or by deposits of the coarse sand and gravel washings eroded from localities upstream. The rural flood losses from the ordinary floods consist principally of crops and live stock destroyed, or in some localities, the partial destruction of farm levees.

At the best, statistics of losses must be in the nature of estimates, for most of those directly affected have no accurate idea as to their loss. This is a class of statistics in which the collector must exercise considerable discretion, but intelligence and ingenuity will bring results.

Indirect Losses.—In addition to the physical damage, that flood disaster creates indirect losses very difficult to measure, and for this reason usually omitted in the estimate of damage. They are, none the less, necessary

to a consideration of practical expenditures for flood relief. These losses will include those arising from the paralysis of business, manufacturing, merchandising, transportation, labor, and the suspension of industry in all forms. There is further the indirect loss occasioned by sickness and death. A very important source of indirect loss is the depreciation in property brought about through the increased emphasis of the flood menace in the locality inundated. Corrective measures may overcome this loss, but in the absence of protective measures the loss is very important, particularly in a large city. Since the 1913 flood in the Scioto Valley there has been very little demand for farm land lying below the flood plain, and in consequence the value of such farms has considerably depreciated.

The railroads usually endeavor to estimate their losses both direct and indirect quite accurately. With the assistance of the railroads, an estimate was made showing the railroad losses in the counties watered by the Scioto River during the flood of March, 1913. With two or three exceptions, the figures on losses were furnished by the railroads themselves. The inquiry resulted in an estimated direct loss of \$1,613,860, and an indirect loss of \$2,494,500. According to these figures, the indirect loss is about 60 per cent. of the total.

The indirect loss reported by the railroads consists principally of losses due to suspension of traffic; that is to say, loss of revenue from transportation. This does not take into account the loss of goods in transit. It appears that the railroads have not been held responsible for loss of goods under the conditions that occurred in the 1913 flood.

If the railroads suffered this large indirect damage, what shall be said of the losses sustained by the shippers. This is a loss that is by no means confined to one locality, but permeates the whole country. We hear little of this source of loss, probably because that arising from any particular flood is distributed thinly in varying degrees over many States.

That the indirect loss is by no means confined to the

localities of the flood is well evidenced by the fact that railroad transportation was not completely resumed in Ohio for many weeks after the flood. There were certain localities in which travelers were not allowed unless it could be shown that their business was urgent. Commercial houses of the jobbing centers in Chicago and New York found it necessary to recall their commercial travelers, and the sale of goods was not fully reestablished until the devastated towns were cleaned up and the railroad traffic restored. A comparison of the bank clearings at Columbus by days, taking into consideration the normal fluctuations for the different days of the week, indicates a loss in bank clearings for the flood week aggregating slightly over \$2,000,000.

It is true that the loss in bank clearings is not all a total loss to the community. Some business was temporarily suspended and made up the loss later. Upon the other hand, there is a large local indirect loss that does not appear in the bank clearings. Only a part of the cash transactions thus appears, and there were losses in the industries due to reduced output that would not show in bank clearings in some cases for weeks or months.

Annual Flood Loss.—In cases where the loss from a flood is not very excessive, it must be the annual flood loss over a long period of years that will justify expenditures for flood relief. It is important to consider, however, that where a community is growing, even if the floods remain the same, the property subject to damage must increase with the increased population of the flood plain. For this reason, a scrutiny of the past is of very great use as a guide to justifiable expenditures, but the fact must not be overlooked that it is the future flood losses without protection that properly fix the warranted expenditures.

Where, however, a locality is subjected to a tremendous loss accompanied by great loss of life, particularly if the heart of the city is affected as was the case at Dayton, Ohio, in 1913, then it will be necessary to consider in the debits and credits what the future will bring forth with and

without protection. This is particularly important in a case like Dayton where the very life of the town is affected. It must have protection or its growth will be stopped. In a lesser degree this applies to cities partially flooded such as Columbus. No city or locality can progress as it should in the face of a constant flood menace.

In the justification of expensive works for flood relief, the fact must further be considered that such works are usually constructed through bond issues covering a generation more or less. In this connection it is proper to consider that populations and values are constantly upon the increase in prosperous localities, and, therefore, while the tax rate of the immediate future must necessarily be considered, it is well to remember that with adequate protection, growth in value will automatically cut the tax rate. In other words, a great work for flood relief is a permanent work. It benefits not only the present generation, but generations to come for an indefinite period. It is proper, therefore, that the cost in so far as possible, should be distributed in accordance with benefits, and while under our present laws there is no way to assess the indefinite future population, yet long-term bonds are perfectly proper and will ultimately be retired at a reduced cost per capita.

INVESTIGATIONS RELATING TO PHYSIOGRAPHY

It is necessary before it can be predicted what alterations in the flood plain or river channel are required for flood relief, to determine the shape, form and dimensions of the channel through which floods must pass, and further, to determine the underground and underwater conditions so far as they affect the problems that must be solved. The word "physiography" implies a description of natural conditions, and while, to a large extent the topography and geology are shaped and affected by natural causes, in cities particularly, there are important modifications in the natural conditions due to the works of man. These things must be measured and located in so far as they affect the problem in hand.

It cannot always be foreseen just how the topography in a certain locality will affect the problem in hand. There will be places where the conditions are more or less governing, and there will be other places where a less exact determination of conditions will fulfil the purposes of the particular investigation.

Very much can be learned through a careful reconnaissance of the territory affected, particularly as indicating the places where detailed surveys are advisable. The extent of territory that it will be necessary to cover by surveys will obviously depend upon the scope of the territory that it is proposed to protect, and the area of the river system that affects the flood problem of the locality to be protected.

Existing maps should obviously be used in so far as they are useful. The ordinary map, however, represents the existing conditions only in one plane. Its purpose is usually to show property, and therefore it usually imperfectly portrays river conditions. Furthermore, in the consideration of floods, one is interested in depths as well as areas, and therefore in one way or another the topography over a large extent of the country must be determined perhaps in considerable detail here and less detail there, perhaps accurately surveyed where dam sites are proposed, and surveyed and mapped by the less accurate so-called "stadia" methods where reservoir sites are to be located or where channels are to be improved.

To the layman a view of the ground is most enlightening, and to the engineer while a careful view of the ground is very necessary, for there are some things in nature very difficult to portray on maps, yet nothing can displace the accurate topographical map. To the engineer it does more than portray the conditions as they appear to the eye, in that it supplies dimensions vertical and horizontal, and permits the estimates of quantity from which costs must be computed. The maps prepared by the U. S. Geological Survey are ideal for the purpose of general reconnaissance. Supplemented here and there where they indicate conditions favorable to flood remedies, they furnish an excellent

groundwork for the more detailed topographical surveys that will be required in working out special problems at special places. These maps have been invaluable in the investigation of the Ohio flood problems. The entire State has been covered by geological surveys and maps or proof sheets are available for practically the whole State. These sheets were used to determine accurately the drainage areas tributary to various points upon the river system. They were found to be quite accurate in their general portrayal of the river valley and flood plain conditions within their limit of accuracy. They were further found to be sufficiently accurate to determine the contents of reservoirs formed by high dams within 10 per cent. and were of great use in locating the dam sites and reservoir sites in the projects of flood relief by storage.

In the investigation for Columbus and the Scioto Valley, the problem was to determine first, the scope of territory that profitably could be included in the flood protection district under the Conservancy Law of Ohio, and second, the best method for protecting this district. The total drainage area of the river is 6,481 square miles. Early in the investigation it was determined that the lower reaches of the river could not be included in the protected district profitably, and further research was confined to the upper half of the watershed, and more particularly, to the upper one-quarter of it. It was necessary, however, to determine river cross-sections up to the high-water plane on something over 150 miles of river, including the lower ends of the principal tributaries. These general sections were taken at intervals of from 1 to 3 miles and were located at the most important places as determined by the topography disclosed by the U. S. Geological Survey sheets. More than two dozen dam and reservoir sites were located upon the Geological Survey sheets. The capacities of the reservoirs and the contents of the dams were computed. As soon as the investigation had progressed sufficiently far to disclose the most favorable sites, these sites were surveyed. An area of 50,000 acres was thus covered by

TABLE IX.—COST OF TOPOGRAPHIC SURVEYS MADE BY STADIA

	Acres surveyed	No. in stadia party	Purpose of survey	Contour interval, feet	Average acres per day	Average readings per day	Cost per acre, cents		Remarks
							Field work	Total incl. map	
Idaho	56,000	8	Probably irrigation	2	082	473	7.7	12.1	Average square mile had 40 to 70 feet variation in elevation, 20 per cent. rough.
.....	15,000	7	3	60.6	300	40.7	82.5	
Ill. Pa.	107,500	Mapping coal areas	10	6.4	18.1	
.....	3 to 6 in field	Irrigation	Land partly developed by orchards and canals and partly covered with sage brush. Topography only level parties not included.
Wash. Dec, 1910 to January, 1911 Acres surveyed.....	83,610	1	16	27.6	
Los Angeles.....	8 (recorder)	Aqueduct	5	Av. = 520 Min. = 240 Max. = 845	Very rough country.
Davenport (approx.)	7,000	4	Sewer design	1 to 5	180	12	Three-fourths open and rolling, one-fourth rough and wooded.
Riverside, Cal.....	7,449	5	Industrial development	2	74½	500 to 600	22	29.8	Rolling, cultivated. 300 feet difference in elevation.
Columbus, Ohio:									
Dublin Reservoir....	18,000	4	Flood	5'	200	143	8.5	11.7	
Delaware Reservoir..	23,000	4	detaining	5'	250	328	6.35	8.07	
Flint Reservoir.....	9,000	4	basins	5'	100	153	12.95	17.35	

stadia surveys. Table IX shows the progress made by these survey parties, the cost of the surveys and the comparison with several other topographical surveys for which cost was available.

For the purposes of the preliminary report, channel sections within the City of Columbus were taken at intervals of from 50 to 100 feet and tied into the existing city property map. The official plan required a more detailed topographical survey.

Underground Conditions. It is obvious that the underground conditions must not be overlooked in so far as they bear upon the problems in hand. It need hardly be said that dams and levees must have suitable foundations, and the types and the locations of structures to be built cannot be determined until these foundation conditions are known.

The conditions underground not only determine the kind, form and dimensions of the structures to be built, but they affect the cost of such structures as dams and levees, and also the excavations that may be required for channel alterations, channel straightening, cutoffs and the like. There is an endless amount of detail in this subject and it is an important function of the experienced engineer to determine how far investigations are warranted in the problem in hand. For the requirements of a general case, investigation may often be met by reconnaissance surveys, particularly in the light of an intelligent consideration of deferring more detailed investigations until the investigation has been narrowed down to a subject that seems most feasible. When the lines of investigation are well defined, been determined, then preliminary surface and underground surveys must be supplemented by the use of borings and borings in many places. Some of the results of preliminary investigation.

Where underground conditions are important, investigations may well be directed to the following lines. First, a general reconnaissance survey to obtain general information that may be of assistance regarding the

ity. Second, a search by inquiry where information regarding borings may be available, particularly wells, and third, where the accuracy of the data requires it, test pits and borings are useful in determining rock topography and the character of general underlying materials. Borings are frequently misinterpreted, and it is very important to avoid being misled, that they should be accompanied by a reasonable number of test pits where conditions make it practicable.

INVESTIGATIONS RELATING TO HYDROLOGY

It need hardly be said that the correct solution of the flood problem will depend upon an intimate knowledge of floods. Although it is future floods that must be controlled, the past must carefully be studied to determine most accurately what the future has in store. Therefore, the science of water, its properties, phenomena and laws occupies an important part of the study that must be given to the correct solution of the flood problem.

That locality is particularly fortunate where river statistics have been sufficiently appreciated so that records of gage height and flow have been taken and preserved over long periods. Where such records are available, they are invaluable in that they permit the outline of adequate remedies with an accuracy that is not possible without them. In their absence, the facts that they determine and the lessons they teach must be disclosed on the particular river in question by circumstantial evidence in so far as search determines evidence at all supplemented by experience in other localities possessed of records, and having conditions similar to the problem in hand.

The general public is slow to realize the value of hydraulic records. In fact, records of any kind are the accompaniment of maturity. Generally, it is the man past the prime is the most interested in history, and likewise older civilizations that records of the past are may to go back 100 years in Pennsylvania 70 years in Oklahoma. For these

reasons we have a few stream records about 100 years long in the eastern part of the United States. In the Middle West the data is more or less hazy with a few exceptions, for more than a generation in the past, and further west, the records are usually much shorter.

Nearly all our records of rainfall, and practically all our data on stream flow have been collected by the U. S. Weather Bureau and the U. S. Geological Survey during the past 20 years, and particularly during the past 15 years. Fragmentary records of gage height and stream flow are to be found in every State in the Union. Through the lack of Government appropriations in recent years, these data are all too fragmentary. In addition to the work of the Geological Survey, the U. S. Weather Bureau maintains gages at one or more places upon the principal rivers of the country. A few of these records are 20 years in length. Observations are taken usually at sufficient intervals to fairly define the variations in stream flow. Ordinarily, the observations are taken at a specific time each day, and at shorter intervals during periods when the river stages are changing rapidly.

Gaging Stations.—To directly and accurately measure the flow of a large river is a task not easily accomplished. It is one that requires preliminary preparation and considerable skill. It has been observed, however, that other factors remaining the same, the flow of a stream will bear a fixed relation to the gage height. This relation is not direct; for instance, to double the gage height very much more than doubles the flow, for in the ordinary river cross-section, increased depth is accompanied by increased width, and usually increased water velocities.

This relation between gage height and flow has been extensively utilized by the U. S. Geological Survey and others, to secure flow data over a very much more extensive territory than would be possible in any other way, for when the approximate relation between gage height and flow has been determined for the conditions at any particular gage for the various stages of water that prevail, it is then only nec-

essary to maintain a daily reading of gage height, and the approximate flow of the stream from day to day can be determined.

This relation at any particular place between gage height and flow is termed a "rating curve." It is not necessary to measure the flow of water for each gage height, but the measurements should be distributed fairly uniformly between high water and low water. The larger the number of measurements, the more accurate the determination of the curve or relation.

In comparing gage heights and flows, as in preparing a rating curve, it is noticed that the separate measurements of flow at a given gage height may differ more or less. Assuming that the river channel has not changed at or below the gage, these variations are usually accounted for by changes in the slope of the stream and hence in the velocity of the water when passing a gage at a given height. The slope variations are most prominent in a rapidly changing stage of river. Usually a rising stage tends to increase slopes which flatten out under a falling river. The converse may be true, however, depending upon the origin of the flood water.

So far as the aggregate of flow is concerned, that is, the bulk of water passing the gage in a month, or more particularly in a year, the ordinary rating curve is quite accurate. Its accuracy is much less in the measurement of the apex rate in a particular flood. In order that better knowledge may be obtained of the flow during such a time, it is advisable that the governing slope at the rating station shall be determined during the current meter measurements which fix the gage relation, and especially during floods that observations shall be taken that will disclose the flood slope. This can usually be done by observing two gages sufficiently separated so that small errors in reading and in location of observations will not introduce serious error.

There are some localities particularly where great changes are periodically taking place in the river channel from month to month and from year to year where a gaging sta-

tion is of minor value. This is particularly true in some of the rivers of the Southwest that pick up their beds in flood, so that the cross-section changes to a greater degree than would be evidenced by a survey in the dry season, the only time when a survey of a cross-section would be accurate. Most of our rivers, however, have cross-sections that are fairly stable, so that gage height and flow relation is reasonably constant.

Construction of Rating Curves.—A rating curve is usually constructed as stated above, by plating a diagram of gage height and measured flow. Flood investigation is usually instituted after the flood has subsided, and it may be many years before another opportunity arises to measure a great flood. In such cases where a rating curve is desirable, it must be constructed from actual measurements in so far as possible, supplemented by computations. Immediately the investigation is started, it is well to establish gaging stations wherever hydrographs will probably be desired and to take current-meter measurements as opportunity offers, thus establishing points upon the rating curve. Where the flood investigations cover several months or more a very good curve can sometimes be obtained in less than a year. If the rate during a great flood has been determined according to any of the methods hereinbefore described, the result of this estimate can be platted on the diagram, and forms one of the points from which the curve is drawn. The curve between the great flood and actual current-meter determinations may be approximated by projecting the current-meter observations, or if there is a considerable difference in gage height between the great flood and the highest stage for which a measurement is obtainable, it is useful to compare relative cross-sections, comparing the gage heights and the flows upon the assumption that the slope remaining constant, the flow will vary directly as the cross-sectional area and the square root of the mean depth. The use of logarithmic paper will be found very useful in the construction and estimation of rating curves.

It need hardly be said that as the opportunity arises to substitute actual measurements for computations, the rating curve should be corrected. In investigations at Columbus it was impossible to await the completion of the measurements. The curves were constructed when needed, and were modified afterward where necessary in the light of subsequent measurements, the hydrographs being modified if the changes were sufficiently important. In general the changes were slight, and the use of computed



Fig. 14.—The flood passing the Scioto river storage dam, afternoon of March 25, 1913.

This furnished an excellent means for measuring the flood.

rating curves much facilitated early conclusions that were very necessary to properly direct subsequent investigations.

In the Columbus investigations a very good check was obtained by comparing the resulting hydrograph with the closely estimated runoff and rainfall above the Columbus storage dam. A close estimate of the rainfall as compared to the runoff over this dam indicated that 93 per cent. of the rain that fell in the great storm ran off within about 10 days, at which time the river had returned practically to normal flow. This relation between bulk of rainfall and bulk of runoff served as a very useful check on the rating curves and hydrographs for other places upon the watershed.

Flood Measurements.—It is found almost invariably, that flow data is lacking at some of the places where knowledge would be desirable in the consideration of any

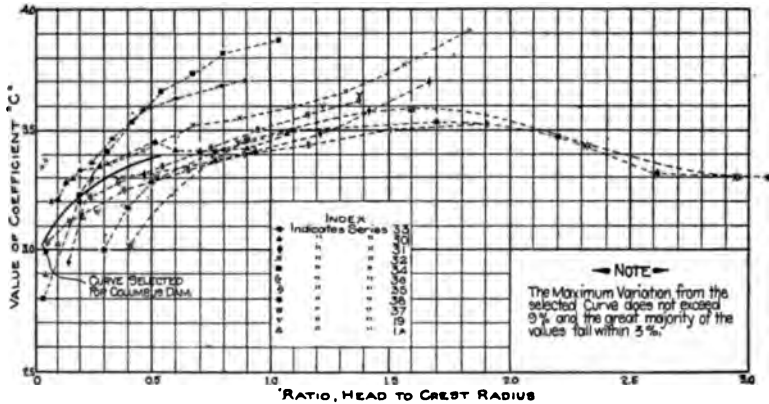

FIG. 15.—Diagram showing relation of "C" values to the ratio of head to crest radius. Experiments on curve crested dams.

This diagram illustrates the close interrelation between head crest width and flow value in flows over dams.

large flood problem, and it frequently happens that practically no data is directly available that would indicate at once the magnitude of the flood rates. The best and most

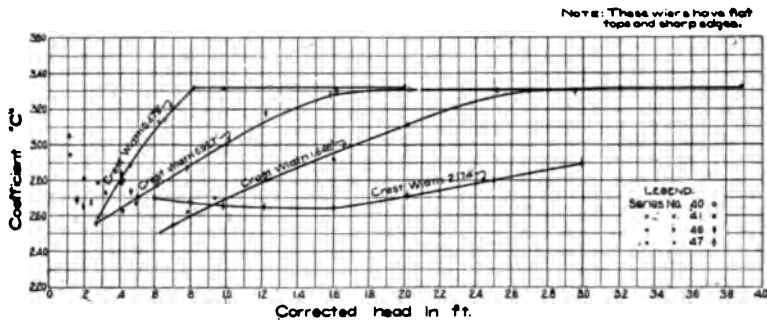

FIG. 16.—Experiments on flow over broad-crested weirs Cornell University Hydraulic Laboratory, 1903. (U. S. Geological Survey—Water-Supply Paper No. 200.)

These experiments illustrate the importance of considering crest width parallel to the stream in selecting wier coefficients.

accurate means of determining these rates is to measure them directly during a flood by the aid of a current meter, but this usually is not practicable, for investigations for

flood relief are usually brought about through the flood itself. The investigation follows the flood and therefore the best that can be done usually is to determine what happened through the record that was left. The shorter the time between the flood and the flood investigation, the more accurately the flood happenings can be determined.

The flood of 1913 upon the Upper Scioto River all passed over the masonry dam of the Columbus Water Department. At normal stages of water this dam creates a head



FIG. 17.—The flood passing the Big Four R. R. bridge at Delaware. The 1913 flood "headed up" nearly 5 ft. at this bridge, furnishing means for an approximate estimate of the flow.

of about 30 feet. It has the usual curved vertical cross-section of masonry dams. During the flood the tail water remained below the crest, so that by the aid of the gage height records immediately above the dam, the flow could be estimated with considerable accuracy through the aid of the experiments that had previously been made upon weirs with rounded crests. In the present status of hydraulic data, a dam thus furnishes the best means for finding the flood rates in past floods.

Floods usually find the water course more or

less obstructed by works of man, particularly railroad embankments and bridge openings. The inadequate opening can be utilized as an index to flood rates that prevailed, providing data can be secured as to coincident heights above and below the obstruction. Flow data secured in this way should be used only with caution unless checked by all other available means of estimate. It would be of great advantage if knowledge of hydraulic data could be extended to include experiments on the relation between flow and lost head upon river obstructions similar to bridge openings. Inadequate bridge openings very frequently furnish the only good guide to flood rates after the flood has subsided.

To determine the flood rate it is frequently necessary to resort to river cross-sections and slopes as determined by surveys of the river valley and high-water marks. There is no application of hydraulics that may appear to produce results so uncertain as this method. The application of flow formulæ to flooded rivers will be further discussed under channel improvements, but let it be said here that considerable experience has indicated that the largest error arises through imperfect slope determinations, and, therefore, that the most accurate results can be obtained by the consideration of a long reach of river, that is to say, several or many miles in length on the large rivers where the fall is comparatively slight.

The error in slope determination is threefold. First, high-water marks or even gage heights are not very accurately determined. The gage is usually read only to the nearest tenth of a foot. Second, a line drawn through the flood marks may not indicate slope at all. That is, there may have been no time during the flood when the slope corresponded to a profile through the flood marks, for the flood marks are formed by the progress of the crest wave. The consideration of a long reach of river eliminates this error to a certain extent. Third and lastly, the surface of a flood is not horizontal when considering the cross-section at right angles to the flow, but may vary at

different places in the cross-section, depending upon the velocity in an amount that could introduce considerable error in the consideration of a reach where the total fall is only a few tenths of a foot. A reach sufficiently long to obtain a fall of several feet is highly desirable.

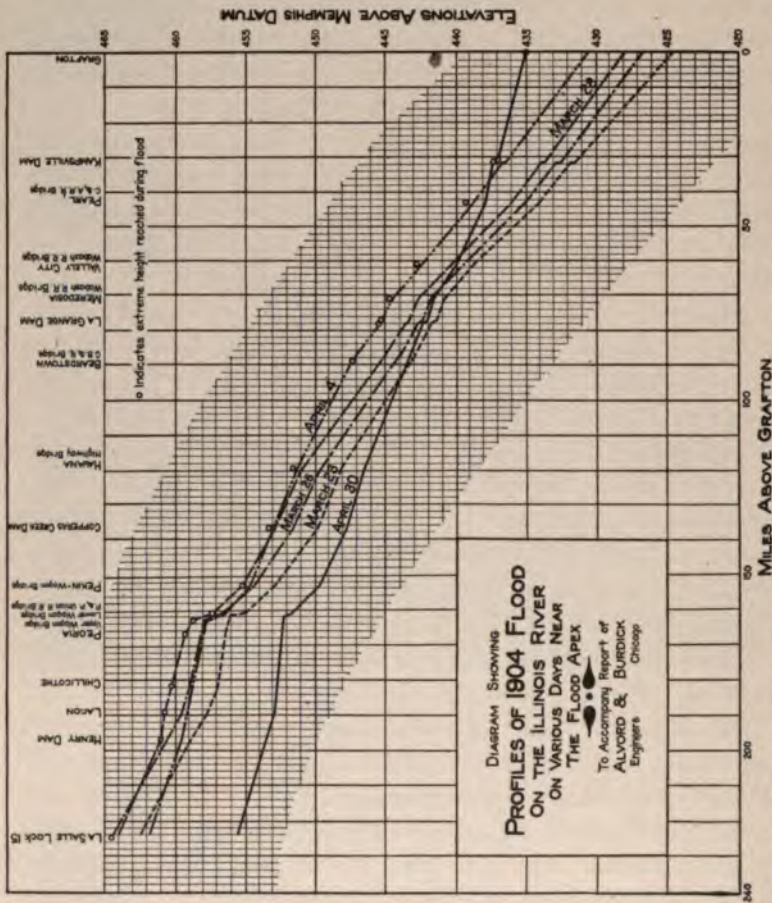

FIG. 18.—This illustrates the point that high-water marks do not always represent the flood profile at any given time.

In estimating the flow by means of cross-section and slope, the fact must not be overlooked that most of our experimental data refer either to artificial channels, or refer to rivers flowing within their banks. When a stream forsakes its natural channel and submerges the adjacent bottom lands, a condition is created quite outside the

compass of accurate experimentation. Although we have no better means of considering these occurrences than to apply the usual flow formulas to them, yet this must be done with caution and consistent results can most readily be obtained by separating the channel section which usually carries the greater part of the water from the land section.

In the estimate of flood maximums, it is of great value to bring all possible checks upon the result, and in so far as it is possible to make it consistent with all the circumstantial evidence that can be brought to bear upon the matter. Thus, generally speaking, the maximums progress downstream not in direct proportion to the drainage area, but usually as some function of the drainage area varying from the square root to the first power. This is particularly true when considering the maximum flood rate regardless of any particular storm. In some particular flood, a different relation may be shown depending upon the localities and magnitudes of the heaviest rainfalls.

Hydrographs.—In channel improvements we are concerned chiefly in the maximum flow rates, but when considering such remedies as storage, then we are interested not only in the maximum flood rate, but it is also necessary to know the bulk of the flood waters. In order that this may be computed, it is necessary to have a so-called "hydrograph" of the flood. This is generally a graphical diagram and indicates the flow rates prevailing during the different hours of the days during the flood. Where a rating curve is available, this hydrograph may be prepared directly from the gage readings. It often will be found necessary, however, to construct a hydrograph where no gage records are available.

In a great flood a graph of gage height in reference to time can often be produced through inquiry as to when the flood reached certain well-defined marks whose elevations are determinable. Thus, in the flood of 1913, the gage upon the Olentangy River at Delaware was washed out early in the flood, and as the business section of the city was flooded a depth of several feet, it was possible to reconstruct a

very good gage height record by inquiring along the streets in the business district which varied in elevation, and determining on what day and hour the flood first intruded upon the floors of the various mercantile houses, and the day and hour when the water had sufficiently receded so that the premises could be cleaned up. After the river had receded within its banks, it was more difficult to plat the height from day to day, but a few determinations when the river had receded practically to normal permitted a fairly satisfactory curve to be drawn.

With the data of gage height determined from actual readings, or in the manner above described, a hydrograph of flow can be constructed.

For many purposes a hydrograph showing the daily flow of the river throughout the year is of use. Thus, in considering flood relief by storage, it will be desirable in some cases to consider water storage for water supply or for water power. This has been an important adjunct of the European works for flood relief by storage. To determine these matters the daily flow of the river throughout the year and through a period of years is very important to the formation of correct conclusions.

Influence of Rainfall.—It is generally impracticable to compute flood runoff from rainfall with any degree of satisfaction, and yet a determination of the rainstorms that have produced great floods when proper consideration is given to locality and the factors that affect runoff are useful particularly in that they furnish a general guide to the importance of such floods as may have occurred upon the river under consideration, and the likelihood of greater storms, and hence greater floods at some time in the future. This matter will be considered in the following chapter.

The U. S. Weather Bureau is rapidly accumulating a large amount of data regarding rainstorms in the United States. Observation stations are well distributed, particularly in the better-settled country, and daily rainfalls
—more important stations and rates for short periods

are available generally for 25 years, with considerable data running back two or three generations.

Very little has been done, however, to digest this information, particularly to determine the magnitude and duration of rainstorms that may reasonably be expected in the various parts of the country, based upon past experience. The data abundantly prove the average variation in rainfalls but storms have not been studied to the extent that their importance warrants.

In the consideration of flood problems, it is particularly important to consider the three factors of intensity, duration and area covered by the storm. In the drainage of cities, the size of the sewers may be governed by the rate of rainfall for so short a period as a few minutes or a few hours in the case of a large city. These short and very excessive rainfalls are of importance in the consideration of small drainage areas such as Cheery Creek at Denver, or the small stream producing a great flood loss at Erie, Pa. The larger flood problems are, however, on the streams of such drainage area, that a large area several hundred or several thousand square miles must be simultaneously subjected to a downpour having a duration of several days. The very excessive storms producing floods upon the small drainage areas may have little or no effect upon the larger rivers, and the average rainfalls over these large areas are very much less than the excessive rates that sometimes fall upon a few square miles.

One of the first studies to determine excessive rates of rainfalls over large areas was made by Mr. Clinton B. Stewart in the consideration of the floods on the Wisconsin River.¹ For Wisconsin conditions, Mr. Stewart concludes that rainstorms may be expected about once in 50 years in the amounts and on the areas as shown in Table X.

It has remained for the Miami Conservancy District under the direction of Mr. Arthur E. Morgan, Chief

¹ *Western Society of Engineers*, vol. 18, p. 290.

RELIEF FROM FLOODS

TABLE X. PROBABLE MAXIMUM RAINFALL CONDITIONS ABOUT ONCE IN 60 YEARS

By Clinton B. Stewart

Time period in days	Inches of rainfall for specified areas in square miles		
	500	1,000	2,500
2.	10	8	6
4.	11	9	7
10.	13	11½	10
30.	15	14	13

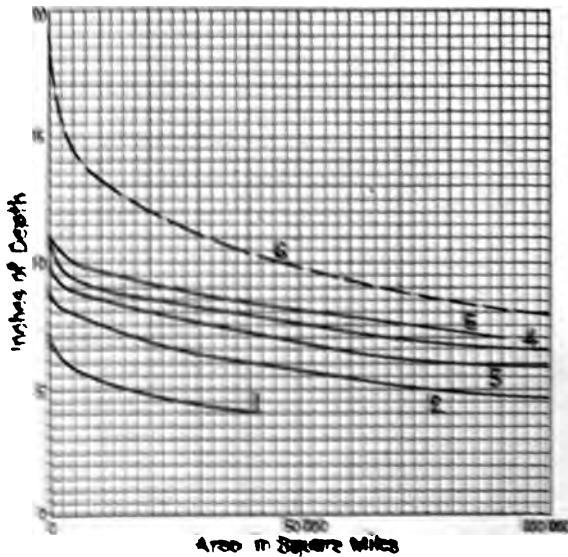

Note: 1 Storm of Mar. 25-27
 2 " " " 24-25
 3 " " " 23-27
 4 Storm of Mar. 25-26
 5 " " " 23-27
 6 Ohio Maximum Storm (see text)

FIG. 10. Area-depth rainfall relations Ohio storm of March 25-27, 1913.

Reproduction from studies made for Miami Conservancy District by the Morgan Engineering Co.

Engineer to search the records of the eastern United States and to find a number of storms, area, depth and a considered which exceeded the great Ohio storm.

A number of these storms are indicated graphic-

20 and 21.

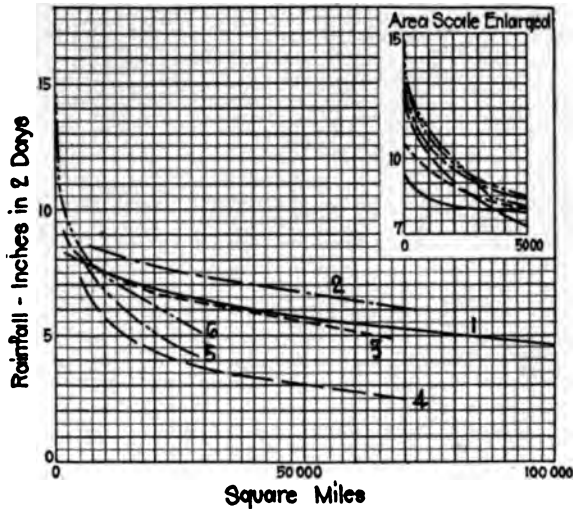

- 1 Indicates Ohio Storm March 24-25, 1913.
- - - 2 Southern Illinois Storm Oct. 5-6, 1910.
- · - · 3 Northwest Mississippi Storm Nov. 17-18, 1906.
- - - 4 Iowa Storm June 9-10, 1905.
- · - · 5 Northwest Iowa Storm July 14-15, 1900.
- - - 6 Southern Iowa Storm August 15-27, 1903.

FIG. 20.—Area-depth rainfall relations—two-day storms.
 Reproduced from studies made for Miami Conservancy District by the Morgan Engineering Co.

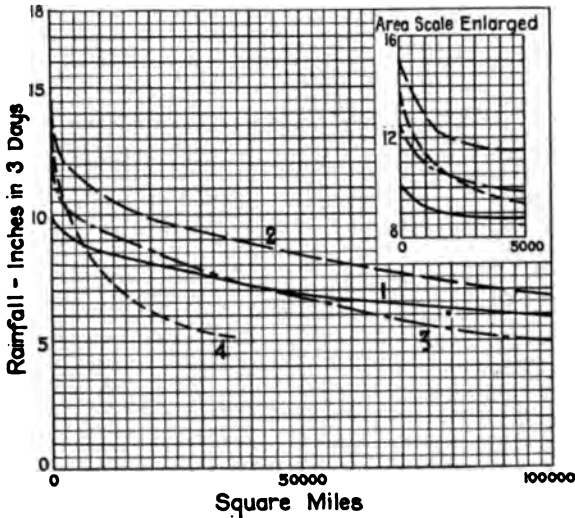

- 1 Indicates Ohio Storm March 24-26, 1913
- - - 2 Southern Illinois Storm Oct. 4-6, 1910
- · - · 3 Northwest Mississippi Storm Nov. 17-19-1906
- - - 4 Northwest Iowa Storm July 14-16, 1900

FIG. 21.—Area-depth rainfall relations—three-day storms.
 Reproduced from studies made for Miami Conservancy District by the Morgan Engineering Co.

RELIEF FROM FLOODS

The U. S. Weather Bureau has shown, Fig. 22, that the watershed of the Ohio River is directly in the pathway of

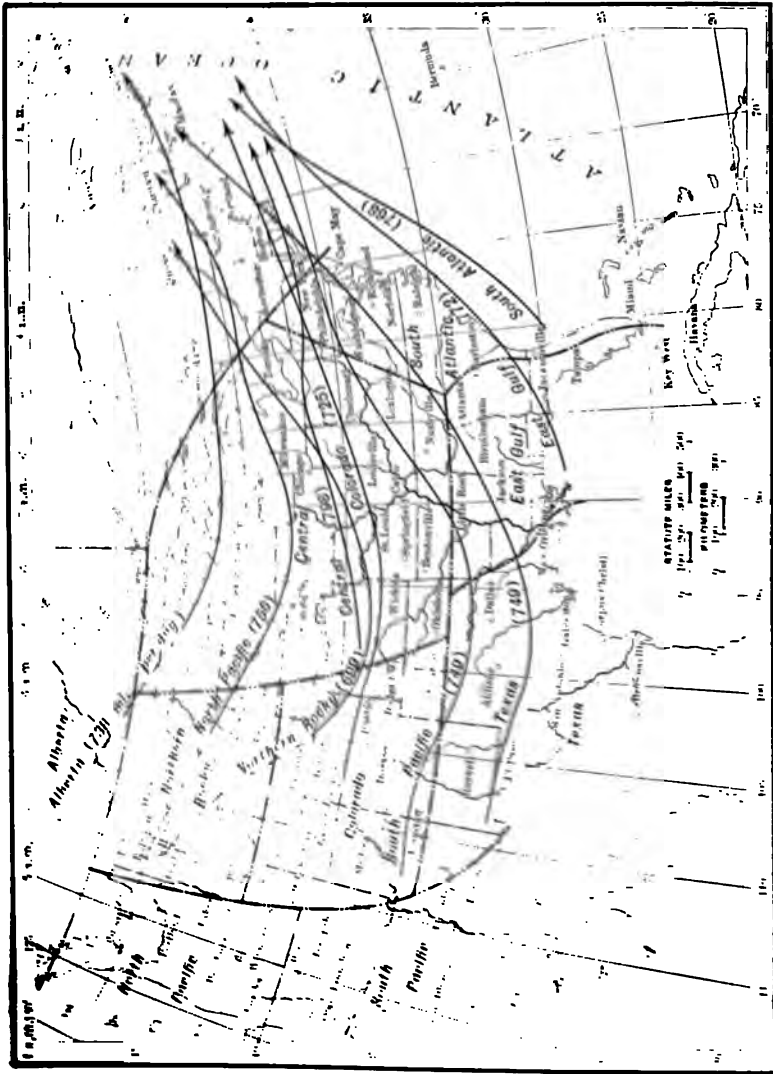

FIG. 22 - Heights of origin of the storms of the United States; and the average January track of each type. This is typical of storms at all seasons.

that rainstorms originating in Central North Gulf of Mexico. This doubtless partly account heavy flood rates in this region.

and while no one will contend that this middle western region could be subject to the storms of the Pacific coast or the tropics, it would be desirable if knowledge on this subject could be extended. Studies by Prof. D. W. Mead made for the Miami Conservancy District indicate that the great 1916 storm of the Carolinas could not have survived the passage of the Appalachian Mountain system and entered the Ohio Valley for a reason similar, but less in degree to the fact that we have the arid Nevada deserts immediately across the mountain range from the well-watered Pacific coast.

CHAPTER V

PROBABLE MAGNITUDE OF FUTURE FLOODS

In looking into the future we are permitted to see no further than may be indicated by a thorough study of the past. A correct interpretation of the past is an extremely valuable guide, providing that the retrospect is sufficiently long so that it may reasonably be assumed to have included all the combinations of circumstances that are likely to occur in the future. The length of record thus required, and the accuracy with which the past serves as a guide for the future, depends first, upon the nature of the prediction that is desired; second, the rapidity with which the recorded events transpired; and third, the circumstances surrounding these events past and probable future.

In the consideration of great floods we are dealing with a phenomenon of comparatively rare occurrence, and thus valuable deductions can only be reached after considering a record many years in length. It is an occurrence, however, the circumstances surrounding which except in special instances have not changed very greatly during the passage of many centuries and, therefore, if we can determine the occurrences of the past, say, over a period of several hundred years, we can approach the future with some assurance as to the events that may probably occur sooner or later.

Where the history of a river is limited, it will become necessary to look elsewhere—to examine the history of other rivers as a guide to the future. In the pages which follow, it will be the endeavor to indicate the process of reasoning through which flood history may be utilized in estimating probable future floods.

History.—In the previous chapter, the ways for
and magnitudes have been outlined, and the

facts relating to the great floods that are fundamental to design of remedial works. Having determined the characteristics of the great flood, it becomes important to glean what data can be found relating to the other floods of the past.

This task will be greatly simplified by a long gage-height record, but except for a few rivers in the eastern United States none of our gage-height records are continuous longer than 40 or 50 years, and to determine the past flood heights, it is necessary to search for the floods that were sufficiently important at the time of occurrence to make an impression upon observers sufficiently strong to survive the passage of years through tradition or through a record of some kind. Thus, even in the absence of gage records, the height of the greatest known flood can often be traced with considerable accuracy throughout the course of a river, providing that its banks were fairly well settled at the time of the flood. Upon the Illinois River the flood of 1844 can be traced with considerable accuracy, for at most places it greatly exceeded the subsequent floods, and within the past generation people were living who could point to places upon the sloping banks of the stream that were washed by that flood.

Upon the Scioto River, the height and year of several of the great floods were cut upon the stonework of the canal lock at Circleville. The yearly record of the flood heights covering nearly a generation was secured from a farmer's diary. Near Columbus a farmer was found who, father and son, had occupied a residence upon the sloping bank of the stream since 1824. The father had been acquainted with the occupants of the house since 1817. These people were able to locate quite accurately a number of the greatest floods occurring in a period of about 100 years.

Although newspaper files usually are a source of record as to flood dates, they usually fail to so define the height of the flood that the information is of greatest use. The old settler's memory in regard to floods is usually not to be relied upon unless the height of the flood closely corre-

sponds with some fixed object. His evidence then becomes valuable. One old settler was found who had worked in and later operated, a certain machine shop covering a period of 50 years. His memory as to flood heights was quite accurate on account of the fact that the floor of his shop was only reached in the greater floods, and although only a few floods had been marked, he was able to locate a number of others in reference to the greatest floods, and in reference to the floor and window sills of his building.

It is usually desirable to determine not only the flood heights but the flow rates of the past floods. In the absence of channel changes, a rating curve determining the relation between gage height and flow under the present conditions can be applied to the gage heights of the past. This past gage heights can be utilized directly to read past flow rates. In fact, all the methods mentioned in the last chapter can be utilized to determine the magnitude of the past floods as far as data can be secured.

In comparing recent floods with those of the past, however, it must not be overlooked that upon most of our rivers the natural conditions have considerably changed in the segments of the country. Even upon the prairie rivers, although the river bottoms, that is the flood plain only, of some of the great floods, were more or less timbered. In the past they were thickly timbered. Flood studies upon the Missouri River have indicated that these wood and brush lands retard the flow traveling by land to a much greater extent than swamps in the open swamps and cultivated fields.

History of Other Rivers. When it is recalled that the greatest flood of the Seine River occurred 130 years ago and that the greatest flood upon the River Seine, Paris, occurred about 20 years ago, and that the greatest flood of the Nile occurred a few centuries, we must understand that the records of our records in America is sufficient to be used as a criterion of

sible future occurrence, and that we must supplement

happened upon other rivers. This is particularly necessary on the great majority of our streams where the records cover periods of only about one generation. Many unwise

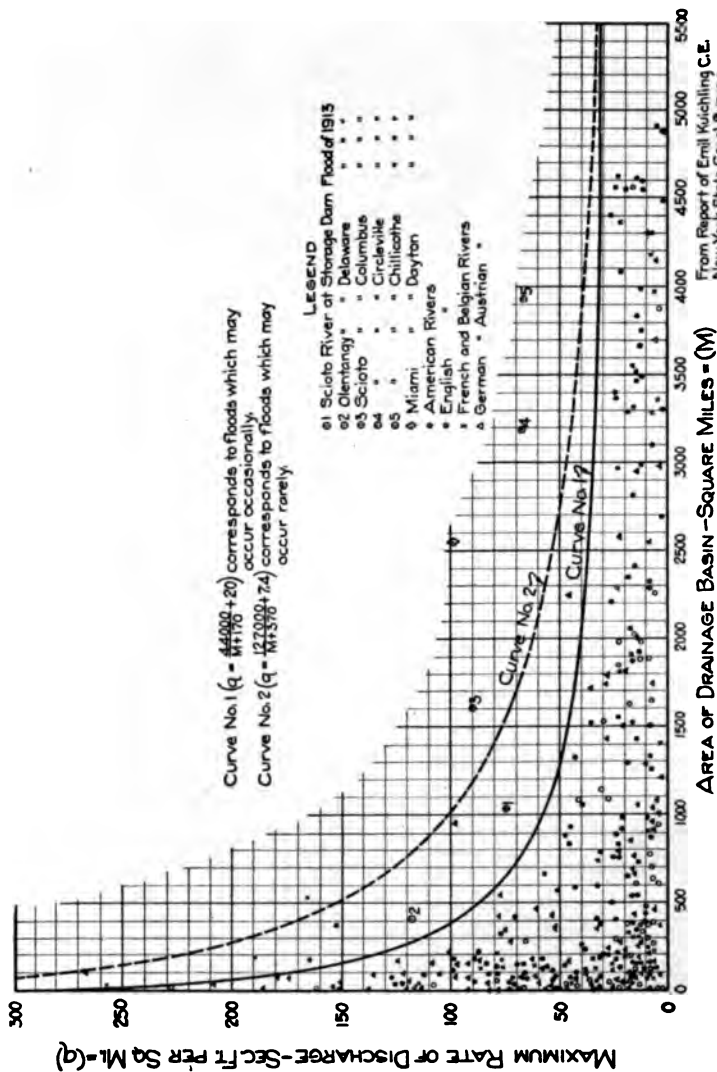

Fig. 23.—Diagram showing rate of maximum flood discharge of certain American and European Rivers. This diagram is platted from the data collected by the late Emil Kuchling, C. E., with some recent floods added.

expenditures have been made through thus failing to appreciate the true importance of time in the determination of the probable flood rate.

Kuichling's Data.—Some 10 years ago the late Emil Kuichling, C. E., did a valuable service when he tabulated after very careful search all the available data of maximum flood flows upon the rivers of America and Europe. He summarized the data thus obtained in diagrammatic form (see Fig. 23) and from the data deduced two formulæ covering first, the greatest floods that are likely to occur occasionally, and second, the great floods that sometimes occur, but rarely. Fig. 23 shows the Kuichling data, the curves representative of his formulæ, and in addition, we have platted upon the diagram the recent great floods upon the Scioto and Miami Rivers in Ohio. It will be observed that the rather accurately measured flood upon the Upper Scioto falls between Kuichling's curves of occasional floods and rare floods, as does also the estimated flood on the Olen-tangy. The estimated floods, however, upon the Lower Scioto and upon the Miami River considerably exceed anything in the Kuichling data.

The data prepared and published by Mr. Kuichling served a very valuable purpose in that it permitted a general knowledge as to maximum recorded unit rates of runoff upon areas of varying size. This data served as a general basis for the design of many engineering works where flood data was lacking, particularly in connection with the spillways of reservoirs where oftentimes exceedingly capacious spillways can be constructed at small cost. In such cases it was often better engineering to provide for the maximum that ever had occurred anywhere, rather than to attempt to define smaller flood rates.

In the larger problems, however, and even in problems of moderate cost where expenditures are largely affected by an estimated flood magnitude, it becomes necessary to determine the flood rate to be expected more closely. Thus, in any project for flood relief, it is readily seen that it is very important to determine whether the maximum runoff per square mile should properly be fixed at 3 second-foot per square mile as on the Crow Wing River in Minne-

¹ Report of the New York State Barge Canal.

sota, or 100 second-feet per square mile as on the Miami in Ohio. To some extent these great variations can be harmonized by a scrutiny of the factors that affect flood flow as previously covered on pages 10 to 16. There has been no way, however, to make an estimate in the absence of direct data with any assurance of reasonable accuracy.

Comparison by Ratios.—It has remained for Weston E. Fuller, in his paper read before the American Society of Civil Engineers in 1913, to suggest the means through which a more rational comparison could be made between the flood flows of various streams.

It has been shown by Mr. Fuller that comparing all the rivers of the United States upon which continuous flow data are published, the great floods on each river bear similar relations to the average annual floods on the respective streams.

If it should be assumed that all the streams of America, for instance, were subject to indentially the same conditions except as to the great flood-producing factor—the great rainstorms—and if we should further assume that all these watersheds in a given period of time would be equally likely to suffer a visitation from such a storm, then it would be reasonable to connect a large number of fragmentary records upon different rivers and make use of the combined record the same as if it were a long record of one river. The object to be gained by a comparison of this kind is, if possible, in the absence of any lengthy record in America, to endeavor to determine what such a record would show.

Mr. Fuller's investigation indicates that by comparing flood ratios, the relations between the great floods and the average floods upon the respective rivers, all differences in the flood-producing factors roughly speaking are eliminated except the chance that the district has been visited by a comparatively great rainstorm within the period of record. Thus, when considering a large number of records on streams of a region subject to storms of the same magnitude, the greatest flood ratio will generally occur upon the river having the longest record. Further, it is

reasonable to assume that other things being equal, it would be practicable from a very long record to determine the average frequency of floods having various magnitudes. There are some hydraulic works where this knowledge is quite useful to economic design.

Twenty-four-hour Averages. -Everyone has noticed that the little brook springs quickly into its maximum flood, and rapidly recedes; also that great rivers like the Mississippi require weeks or even months to reach a maximum flood crest, and as slowly recede. The one is affected by short, sharp storms of small area, and the other by continued rainfalls of many days' duration in widely scattered localities. The brook may have a maximum runoff rate of 1,000 second feet per square mile as compared to 2 second-feet for the great river.

These differences are to a large extent harmonized if, instead of considering crest flood rates, the floods considered are reduced to the average rate for 24 hours for the period nearest to the flood crest.

By comparing a large number of floods, Mr. Fuller has shown the average relation between crest flood rates and average 24-hour flood rates for streams of various drainage areas, the drainage area being the greatest contributing factor. Although this relation varies for even the same river in different floods depending upon the distribution of the rainfall, it is possible to determine an average relation. This has been determined by Mr. Fuller as shown in Table XI.

These data are of use in that they can be applied to a large number of flood records where rates of flow are not available for intervals less than 24 hours.

Flood Frequency. When the problem in hand is the protection of a city where great loss of life may be involved, and where the property damage may be very great, the frequency of great floods may be more or less immaterial, for in the protection of such cases there is no middle ground; no protection is adequate, but is not complete, for the flood of a thousand years may be the only one. There are other

PROBABLE MAGNITUDE OF FUTURE FLOODS 89

TABLE XI.—RELATION BETWEEN MAXIMUM FLOOD AND AVERAGE 24-HOUR FLOOD

$$Q_{max.} = Q_{avg} (1 + 2A^{0.3})$$

Catchment area in square miles (1)	Ratio of maximum flood to average 24-hour flood (2)	Catchment area in square miles (1)	Ratio of maximum flood to average 24-hour flood (2)
0.1	5.00	500	1.31
1.0	3.00	1,000	1.25
5.0	2.23	5,000	1.15
10.0	2.00	10,000	1.12
50.0	1.62	50,000	1.08
100.0	1.50	100,000	1.06

classes of flood protection, however, where possibly something less than complete protection is warranted, and it always serves a useful purpose to be able to form some idea as to what may be expected of flood-relief works when considering their usefulness over a long period of years. A knowledge as to the laws of frequency, if there are any such, would further permit a better idea as to ultimate maximums than would be possible without such knowledge.

Other things being equal, and with no other knowledge available, the greatest flood in a record of 25 years may be considered as likely to occur in the future about once in 25 years when considering a long period. The flood second in magnitude may be considered as equaled or exceeded in the future about once in 12½ years and so on. We know from the history of the rivers, however, that the occurrences of 25 years may be grossly misleading as to the indefinite future. For instance, upon the Scioto River, the period beginning with 1898 and ending with 1913 began with a flood of 75,000 second-feet, and ended with a flood of 140,000 second-feet. There was no other flood within the period that exceeded 36,000 second-feet, and the floods of 1898 and 1913 are known to have been the greatest floods in a century. This example is adequate to show the necessity of going outside of a single stream record for the determination of ultimate maximums in the formation of

correct ideas regarding frequency. Even our longest single records are subject to similar uncertainties; thus up to 1913 a 40-year record upon the Hudson River had produced a maximum 24-hour flood of only 70,000 second-feet, the 1913 storm increasing the record to 108,000 second-feet.

In the study previously referred to, Mr. Fuller has utilized his system of ratios to determine future flood probabilities. This has been done by reducing all the continuous flood records available in the United States to ratios, the greatest flood in each year being set down as a ratio to the average annual flood of that stream. These records have then been treated the same as if added together they comprised one continuous record on one stream, and from these data the laws of frequency for various ratios, and hence for various flood rates upon the respective rivers have been computed mathematically. The flood records added together covered 1,672 years. A mathematical formula was constructed that would as nearly as possible determine the frequency of given ratios in the light of the data shown upon the assembled hydrograph. The probable frequency of various flood ratios has thus been determined by Mr. Fuller as shown in Table XII.

TABLE XII.—RELATION BETWEEN FLOOD TO BE EXPECTED IN A SERIES OF YEARS AND THE AVERAGE YEARLY FLOOD

$$Q = Q (\text{Ave.}) (1 + 0.8 \log. T)$$

Time in years (1)	Ratio of largest flood to average yearly flood (2)	Time in years (1)	Ratio of largest flood to average yearly flood (2)
1	1.00	50	2.36
5	1.56	100	2.60
10	1.80	500	3.16
25	2.12	1,000	3.40

It will be apparent that the value of a flood ratio will depend upon the accuracy of determining both the maximum flood and the average flood. If either is in error, the ratio will be in error. It will further be appreciated in computing the average flood, that the number of years available for average may considerably affect the result.

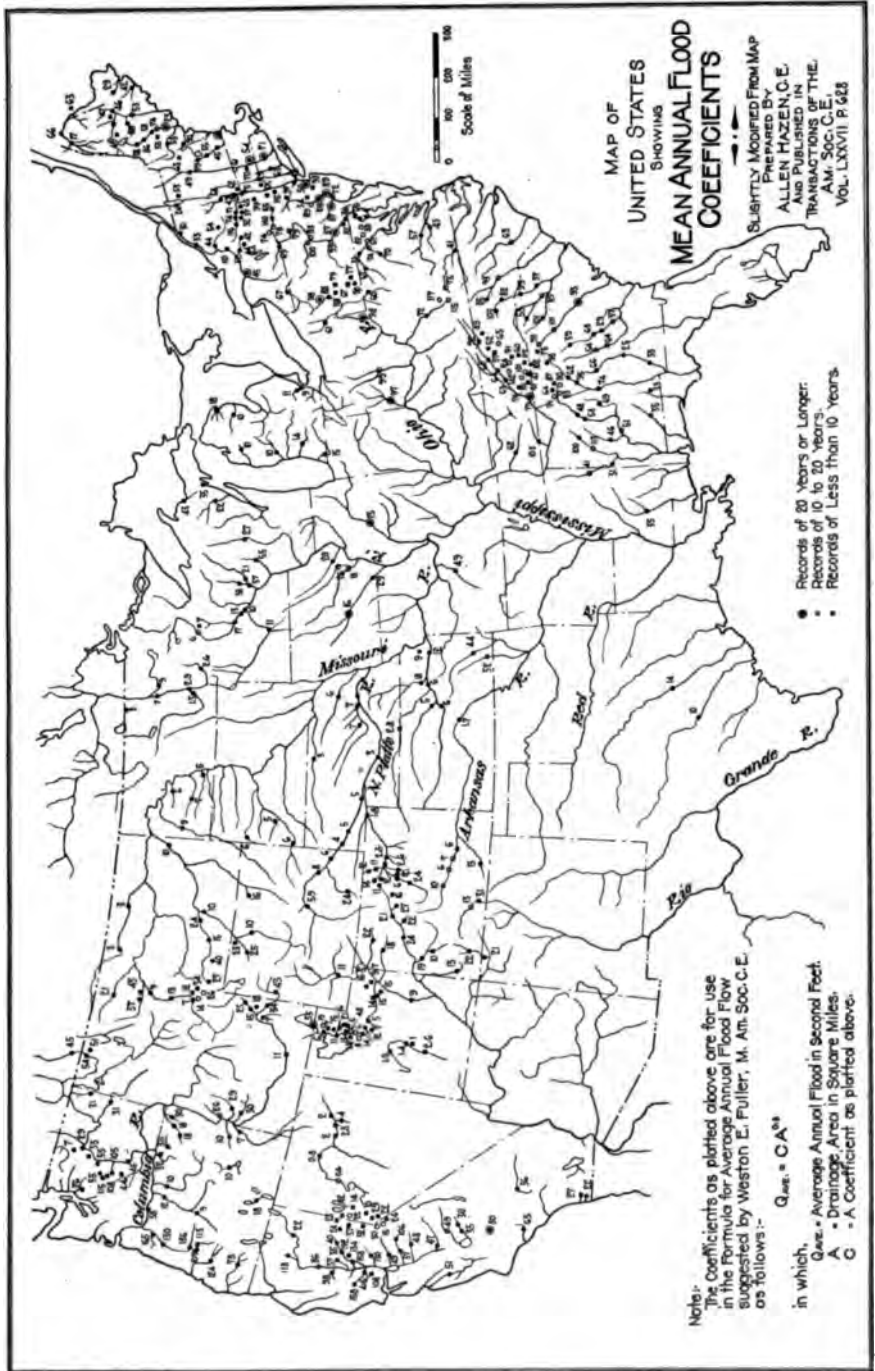

Fig. 24.—Map of United States showing mean annual flood coefficients.

The longer the record the more accurate the average. Reasonably good results, however, are not dependent upon a very long flood record. A trial will show that in from 10 to 20 years the average usually differs but slightly from an average of a much longer period. In cases where very approximate calculations will answer a useful purpose, Mr. Fuller's formula for average flood rates will be found of value in the light of the tables of flood coefficients contained in Mr. Fuller's paper. These coefficients have been plotted by Mr. Allen Hazen, C. E., as shown in Fig. 24 and as plotted upon the map, they show at once the relative flood intensities in the different parts of the country. In examining the map it is interesting to note that the relative magnitude of the floods may vary considerably in a given locality due to the numerous factors affecting flood flows. In northeastern New England it is instructive to note the very small floods on the upper reaches of the main rivers draining the lake regions and the increasing flood rates progressively downstream. The map also shows at a glance the comparatively great flood rates in the Southeastern States and in the watershed of the Ohio River, and the moderate flood rates of the sandy peninsula of Michigan.

Greatest Flood Ratios.—In the light of what has been said above, it will be instructive to set down the largest flood ratios in the United States in the order of their magnitude, as follows:

TABLE XIII.—GREATEST FLOOD RATIOS—MAXIMUM TO AVERAGE 24-HOUR FLOOD RATE—ALL STREAMS IN UNITED STATES WITH 10 YEARS' RECORD OR MORE

Miami at Dayton, 1913.....	4.92*
Kansas at Lawrence, Kan. (15 years).....	3.72
Scioto at Storage Dam, 1913.....	3.52
Shenandoah at Millville (13 years).....	3.12
Savannah at Augusta 20 years.....	2.71
Delaware at Philadelphia (14 years).....	2.70
at Dundee Dam (34 years).....	2.64
at Waterville (18 years).....	2.53

*Ratios at Dayton, not 24-hour rates.

It is not claimed, even by the originator, that the ratio method in any sense supersedes or takes the place of a thorough study of the past floods upon any particular stream. Indeed, the method cannot be successfully applied until a study has progressed sufficiently far to approximately determine the average flood. Rather, the method should be used to supplement the local data. Its great value lies in that it connects the experience upon a single river to all the data upon all rivers. It lines up the local problem with general experience.

It must not be expected that the method will accurately predict the future upon any particular stream. This should not be expected any more than that the actuary tables of the life insurance man would accurately predict the life of an individual. The best it can do is to give the life expectancy of the average man. In the long run, in the indefinite future upon any stream, the conclusion based upon the ratio method will probably fit the occurrences as accurately as the data and the reasoning fits the occurrences of the past. Beyond doubt the data will be improved from year to year, and at some future time it may be possible to somewhat alter the reasoning in the light of the added data. Until such time, the suggestion of Mr. Fuller must serve as our most valuable guidepost to the future.

CHAPTER VI

FLOOD PROTECTION BY CHANNEL IMPROVEMENT

In the preceding chapters we have outlined the investigations and studies that must be made to determine the magnitude of the flood against which it is wise to protect, or what might be called the "provisional flood." Having determined the provisional flood, the inquirer is then in a position to consider the available remedies. In this study it will be wise to give a proper consideration to all means of relief that are reasonably available. If each is pursued a little farther than is necessary to convince the investigator, it will serve more readily and more easily to convince the public. In a previous chapter we have classified the principal means for flood relief. The present chapter will be devoted to the works for flood protection, and in the chapter which follows we will briefly survey the field of flood prevention.

Works for flood protection are more widely applicable than any other means for flood relief. At present they constitute nearly all the flood-relief works in this country, although plans are nearing completion for some very important examples of preventive works, which will be applied in the relief of the flood situation in Ohio.

Even where preventive works constitute the main means for relief, it is often economical to improve the flood channels more or less, for it often will be found that comparatively small expenditures in channel improvements will greatly improve the flood situation, will diminish the expenditures for reservoirs, or will furnish additional protection to districts especially in need of it. Furthermore, even where reservoirs are the chief remedy, channel
be most applicable in certain localities.
the solution of the flood problem

FLOOD PROTECTION BY CHANNEL IMPROVEMENT 95

throughout a river system will involve a proper balance between the works for flood prevention and flood protec-

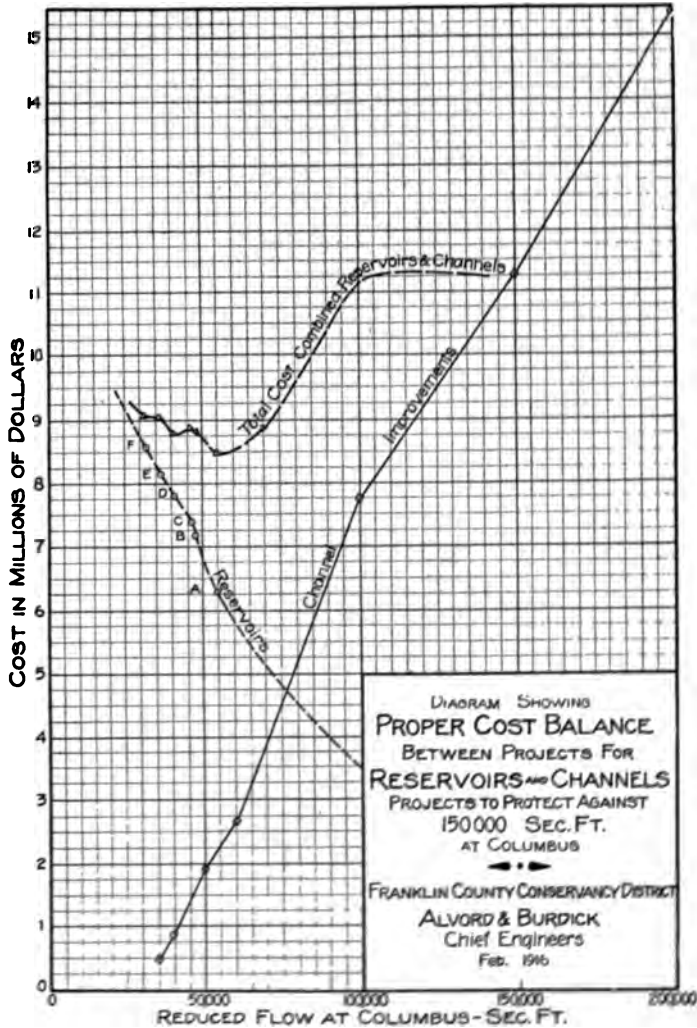

FIG. 25. This diagram illustrates the proper combination of reservoirs and channel improvements to secure protection at the least cost. The sag in the total cost curve indicates the cheapest combination.

tion. It, therefore, becomes very important to thoroughly study the possibilities of channel improvement.

Rivers in Flood.—When one first looks into the matter

of river hydraulics, the most striking thing he sees is the great variation in river discharge throughout the various seasons of the year. Most of the streams of the well-watered parts of the United States have an ordinary low-water flow of about 0.3 cubic foot per second per square mile of drainage area, and flood flows ranging from 10 to upward of 50 second-feet. Thus, most of our streams increase their discharge rates from 30 to more than 150 times in the flood season.

Generally speaking, and excepting the lake-fed rivers, the larger the stream the less the variation in flow; thus, the Mississippi at Cairo has a flood rate about 30 times the flow at low water, and upon the same stream at its mouth the ratio is about 9 to 1.

These variations in flow have an influence upon the applicable types of flood-relief works. Other things being equal, the flashy stream with sharp, short floods most readily lends itself to water storage. Reservoirs to produce a given effect are proportionately more costly where the fluctuations in stream flow are gradual and long-continued, even whether this condition may be due to existing natural storage, or as in the case of some of our great rivers through the distribution of floods over the various tributaries.

The topography of the river valley also has a marked influence in the type of relief works. Comparatively speaking, the Ohio River has no bottoms. The river flows through a "V"-shaped notch. Thus, in order to pass the flood waters, the river rises to very considerable heights, over 70 feet near Cincinnati. Under conditions such as these, levees are practicable only in the protection of property having great value; municipal property for instance.

Upon the Mississippi River the situation is very different. The river banks are comparatively low, and except where confined by levees, extensive areas of bottom land are annually covered. A great flood reaches a width of 100 miles in places, and averages about 50 miles. The variation in flood height is a little more than half that upon

the Ohio. Under these circumstances, levees become practicable for the reclamation of farm land, for a mile of relatively low levee will protect many square miles of bottom land.

Between these two extremes lie most of our rivers. Generally their flood plains have been formed by water conditions very different from those existing in the present era. In many cases the river valleys bear no relation to the present drainage area, as, for instance, the Illinois River which once drained the Great Lakes. Where the bottom lands are wide and flat, levees for the protection of farm land already have proved their practicability, and there are many streams upon which the increasing value of farm land will ultimately justify levees and other forms of channel improvement.

Types of Channel Betterment.—The means for protecting land through channel improvement fall into two classifications:

First.—The exclusion of the water from the land by the construction of levees.

Second.—The alteration of the channel causing it to carry a given flood at a lower gage height.

There are two means by which a lower gage height may be secured for a given flood, namely, to increase the cross-sectional area of the stream or to increase the velocity of the flowing water.

It is obvious that increased area may be secured by dredging the stream for greater depth or by increasing its width through excavation upon the land. The flood capacity obviously can be increased by the construction of auxiliary channels.

Increased velocity can be secured through a greater slope effected by bypasses or cutoffs, which by shortening the length of travel, increase the declivity. The velocity also may be accelerated by promoting the smoothness of the channel and thereby reducing the friction of the flowing water, as in the removal of detritus or other obstructions to the channel, particularly semi-aquatic trees and brush.

The elimination of bends is another means for effecting increased velocity. This usually accompanies a bypass or cutoff.

Each of these means for relief has its place and in any extensive program a number or all of these remedies are usually applied in localities where they are especially favorable.

Reach of River	Average Value of C^2 in Total Flood Cross Section of the Valley of Area of Flood	Approximate Percentage of Land in Timber and Brush
Griffin to Pein	57	42.2
Pein to La Grange	35	23
Griffin to La Grange	56	37
Shawtown to Pein	46	42
Pein to Pein	73	58
Pein to Pein	38	45
Shawtown to Pein	43	32
Griffin to Pein	58	39

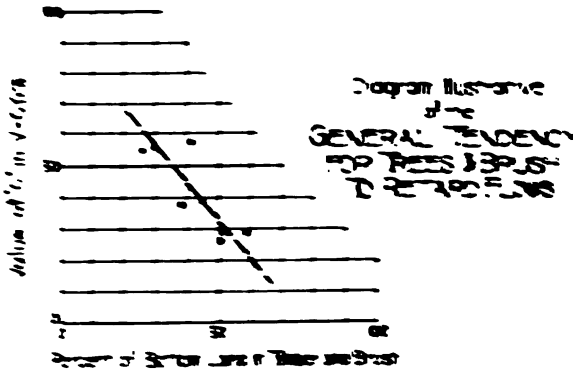

FIG. 26.—Table and diagram illustrating the effects of trees and brush upon the average flood flow values in certain Illinois River reaches, also during the flood of 1915.

Summary—Increased velocities and reduced friction to driving water usually is an accompaniment of any artificial work for channel improvement. Upon the larger rivers, however, this is not a practicable means for increasing the velocity. Upon the smaller streams, however, the...

areas less than say 1,000 square miles in extent, the lodgment of drift and the growth of willows upon the banks down to the low-water bed becomes an important impediment to flow.

The effect of drift, willows and aquatic vegetation becomes increasingly important as the size of the channel diminishes and very seriously impairs the delivery from such artificial channels as main drainage ditches.

Even upon the larger streams where a large part of the flood cross-section is upon land, in the great floods it has been observed that the flood slope and height is considerably increased where the bottom lands are covered with trees and underbrush as compared to the more open or cleared lands. Channels obstructed by vegetation and drift have been an important cause of flood heights in the Marais Des Cygnes Valley in Kansas, according to the report of the U. S. Department of Agriculture.¹ An important contributing cause to the flood heights in the Neosho Valley, Kansas, is said to be the snags, brush and gravel bars resulting from these obstructions in the river channel.²

Cutoffs.—Alluvial rivers like the lower Mississippi and the Missouri and many of their prairie tributaries meander back and forth across their flood plains. They are consequently cutting upon the outside of the bends. This results in the formation of a series of loops, each surrounding an isthmus of land. Ultimately the cutting cuts off the neck of the isthmus and a natural bypass is formed. The slope of the stream is thus increased by the elimination of the long travel around the loop and the velocities accelerated, cutting is engendered so that the bypass is widened and deepened and ultimately the old channel is filled or partially filled with sediment from the successive floods and the reduced velocities around the old loop.

¹ U. S. Department of Agriculture *Bulletin* 234, by S. H. McCrory, Drainage Engineer.

² U. S. Department of Agriculture *Bulletin* 198, by J. O. Wright, Supervising Drainage Engineer.

This process of nature is sometimes imitated in artificial works to improve the carrying capacity of prairie rivers and prevent, minimize or shorten the duration of floods covering the agricultural lands. Extensive improvements of this kind have been made upon the Sangamon and Saline Rivers in Illinois and upon other meandering streams. Generally these improvements are made by dredging, by cutting a new and straight channel often for many miles, sometimes directly crossing the convolutions of the natural river channel or following it where it is comparatively straight.

The prime object of these works is to carry the flood at a reduced gage height. Incidentally there may be a greater apex flood rate at a given place in the downstream portion of the valley occasioned by the reduction in the natural storage of the river valley by reason of the decreased gage height.

If the flooding of the land is prevented, then the natural storage in the river valley is destroyed. The total amount of flood water running off would remain the same, also the delivery of the tributaries to the river valley would be unaffected either in total volume or rate. The result would be that with an improved channel the flow at the downstream end of the river valley would be substantially equivalent to the sum of the tributary flows, whereas in the state of nature the maximum rate would be less and of longer duration by reason of the tributary flows being stored for a time upon the bottom lands of the main stream.

With an improved river, therefore, the water from a given storm would pass off in a less number of days, for it being assumed that there is no flooding of the bottom lands, the storm flow must be delivered at the downstream end of the valley as fast as it is received from the tributaries, excepting a little storage in the improved channel. It is to be borne in mind that although the average rate of flow at the mouth of the valley may be materially increased, it follows that the apex rate will be increased, for it often happens in the

great storms that the tributaries reach their greatest flow rates after the valley of the main stream is substantially filled, in which case the water stored in the river valley rapidly moves forward both in the river channel and by land.

It will readily be appreciated that whether a channel improvement materially affects flow rates below the improvement will depend very much upon how extensively the natural conditions are altered by the improvement. Thus, if the bottom lands normally were flooded to great depth and the improvement prevented their being flooded the effect downstream would be greater than if the lands were normally flooded only to a shallow depth. Also, the extent of the improvement lengthwise of the stream is equally important, in its effect in reducing gage heights and diminishing storage.

The minimum of effect through a cutoff would occur in a case like that of the channel improvements proposed to protect the City of Columbus. The distinctive feature of the remedy was a "cutoff," as shown on Fig. 27. In the application of this remedy it was not intended to deliver any greater flow rates below Columbus than formerly obtained, but to carry the formerly prevailing flood rates past the city at a lower hydraulic grade line. It was not expected that the water levels below the city, and hence the flood rates below the city, would be measureably altered. The tendency would be to increase the rate in some function of the water formerly stored on the area to be protected during the flood. This area was very small relative to the valley and could be shown to have small effect upon the flood rate. If, however, this remedy should be repeated again and again within the river valley, it is conceivable that an important effect upon flood rates might be obtained.

The maximum of effect through increased capacity of a river channel would occur in the following case. The authors have in mind a situation where a flat valley, a great swampy area, had an inadequate natural outlet that was improved by channel straightening so that where the

RELIEF FROM FLOODS

Flood Flow Volume Above Sandusky St	Ufers	Scoto River	Banked Area	MAY ST.
Below Mound St	to Ft. St.	80,000	none	
Above Dublin Ave.		150,000	64,500	
May St			150,000	
Total				
VELOCITY OF FLOW Between Bridges Under	Period	6	10	10
GROSS SECTION OF FLOW Under	Sq. Ft.	8	10	8
CLEAR HEIGHT Road Water to Bridges	Feet	10	10	10
Leaves of Mound above Floodline for Width Side Slopes	Feet	6	6	6
DETAILINGS RESERVOIRS - Elevation above City Datum	None	None	None	None
Scoto River - Grandview Ave		10.5	10.5	
Sandusky St		5.5	46.0	
Mound St		48.0	4.0	
City RR Bridge		45.0	37.4	
Dublin St		30.2	52.7	
Goodman Ave		27.0	41.8	
C.C. & O. RR Bridge		24.0	40.0	
Dublin Ave		22.0	39.0	

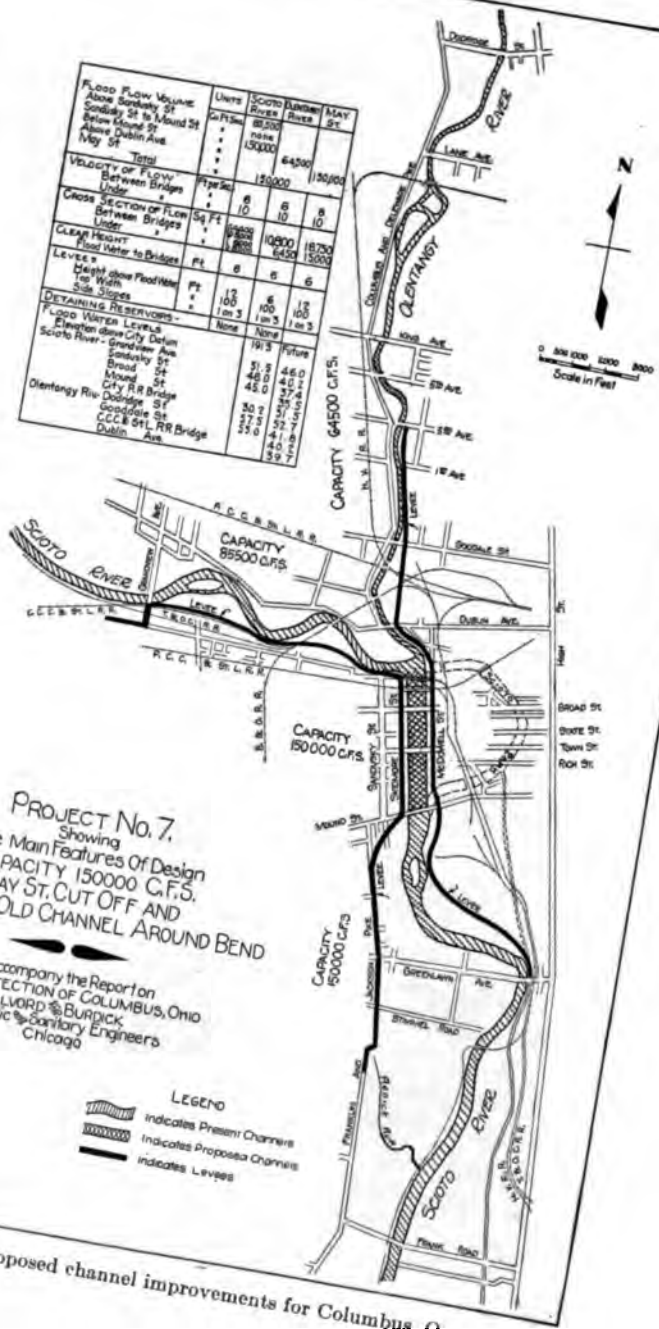

PROJECT No. 7,
 Showing
 The Main Features of Design
 CAPACITY 150000 C.F.S.
 MAY ST. CUT OFF AND
 ABANDONED OLD CHANNEL AROUND BEND

To Accompany the Report on
 FLOOD PROTECTION OF COLUMBUS, Ohio
 ALVORD & BURDICK
 hydraulic & sanitary Engineers
 Chicago

LEGEND
 [Shaded Area] Indicates Present Channels
 [Solid Black Line] Indicates Proposed Channels
 [Dashed Line] Indicates Levees

Fig. 27.—Proposed channel improvements for Columbus, O.

floods naturally stood upon the land for several weeks, the water through this enlarged outlet passed off without flooding the lands. In this case nature provided a detention reservoir which was destroyed through the channel improvements.

Levees and Valley Storage.—The construction of levees adjoining the banks of a stream has an effect similar to increased channel capacity, for in a different way it destroys the natural storage upon the flood plain. The above discussion as to the effect of cutoffs upon the valley storage applies to levees. It will readily be appreciated that with a very large river valley the protection of a small percentage of the land by levees or otherwise could not have a large effect upon the maximum flow rates in the stream. There are some cases, however, where a very considerable portion of a large river valley is occupied by agricultural levee districts. In such a case it might be expected that the effect would be more important. The conditions upon the Illinois River as disclosed in a recent investigation exemplify this condition.

Upon this stream, the total drainage area is 27,914 square miles and the greatest measured flood (1904) about 125,000 cubic feet per second. The stream has wide, flat bottoms for the lower 220 miles, the lands originally subjected to floods totaling 280,910 acres, of which 171,725 acres are at present reclaimed by levees, and nearly all will probably be reclaimed in a few years. The total water stored in the valley on land in the flood of 1904 was equivalent to about 1 3/8 inches on the total watershed. Practically none of the land was then leveed.

It was estimated that should the flood of 1904 be repeated under the present leveed condition of the bottoms, the flood rate near the mouth of the river would be increased only about 5 per cent. due to the reduced flood-plain storage. It was further estimated that with all the bottom lands reclaimed the flood rate would be increased about 10 per cent. This rather unexpected result is accounted for by the fact that in an excessive flood, such as

the flood of 1904, the valley is practically filled with water several days before the apex of the flood, and the maximum flood rate occurs at a time when the gage height is nearly stationary for several days before and after the apex.

The larger effect of apex storage is indicated by further figures. It was estimated, when the bottom lands are fully reclaimed, that if 65 per cent. of the area leveed were held in reserve and flooded near the apex of the flood, storing about 850,000 acre-feet of water, the flood flow rate could be reduced about 25 per cent.

Aside from the fact that river-valley storage is not ideal by reason of gradual filling, it is a fact that the total cubic contents of most river valleys to the plane of the great floods is not very great when compared to tributary drainage areas. Perspective in this matter may be obtained by comparing the relative storage volumes in the proposed detention reservoirs upon the Miami and Scioto Rivers in Ohio with the natural river-valley storage in a few cases where figures are available.

In the Miami Conservancy work five storage reservoirs are proposed, the cubic contents of the different reservoirs ranges from 4.42 inches for the smallest reservoir relative to its drainage area to 8.9 inches over the entire watershed tributary to the largest reservoir. Upon the Scioto Conservancy work, detention reservoirs are proposed of 4.82 inches on the Scioto River and 7.96 inches on the Olentangy River.

The Illinois River bottom lands in the lower 220 miles entirely subjected to floods, range in width from 2 to 5 miles, but the total water stored in the great flood of 1904 was only about 1.3 inches on the total watershed of 27,914 square miles. General Chittenden¹ estimates the storage in the Ohio River valley from Cairo to Pittsburgh as 1,000 billion cubic feet and 2,000 billion cubic feet for the storage in the Mississippi between Cairo and the Gulf. The first-named figure is only slightly over 2 inches upon the 201,000

¹ "Fluvial Practice," International Engineering Congress, 1915, by H. M. Chittenden, *Memphis, Tenn.*, p. 410 (Ret.).

square miles of watershed above Cairo and the Mississippi storage is only about 0.7 inch upon the 1,240,050 square miles above New Orleans.

Channel Enlargement.—The situations are scarce where extensive betterments in the flood conditions can be secured through the enlargement of the channel by deepening or widening. There are local cases where drainage of agricultural lands is financially practicable through this remedy, but usually the property to be protected must be very valuable to warrant the expense of relief by this means. Extensive improvements of this kind are usually warranted only when valuable municipal property is to be protected.

In improvements of this kind, each case is a problem by itself, and it is difficult to draw conclusions generally applicable to this type of improvement. Usually it would be practicable to secure a much more uniform channel, and one offering less resistance to the friction of flowing water than the ordinary river channel, particularly if the number of bridges should be reduced to a minimum, or constructed with ample waterways. Although the loss from a single enlargement or contraction, or from a single bridge opening may be small at ordinary velocities, the loss increases as the square of the velocity, and may become important in the great floods. This is particularly true if the losses are contributed to by many bridges, many contractions and enlargements and changes of direction all of which usually accompany the path of a river through a thickly settled community. These causes of obstruction largely can be eliminated in a well-designed artificial channel.

It is natural to assume that the cost of a new channel or bypass would largely consist of earthwork or dredging. Where the population is congested, as in a large city, the other items of cost are so numerous and so large that the cost of the earthwork may become of secondary importance. Thus, at Columbus, Ohio, the best project for protecting the city by channel improvements involved a cutoff or a new channel traversing the manufacturing and secondary business district. The principal details of the estimated

cost in the Columbus channel improvement project as shown in Table XIV. It will be observed that the cost for excavation was only 22 per cent. of the total as compared to 27 per cent. for dikes and 14 per cent. for bridges. The other 40 per cent. is absorbed by the miscellaneous items including necessary alterations in the steam railroad public utilities, municipal property and an allowance for contingencies.

With high-water land it might be assumed that vertical retaining walls and expenditures to reduce the friction of the flowing water would be warranted. The studies, however, do not indicate this to be the case. It was found most economical to utilize natural earth slopes with an eastern slope for dikes, against west exceed sodding and some bank protection on the bridge. This might not be true in a narrow channel where the sloping banks would form the greater percentage of the total width. The proposed channel is 1,000 feet wide.

These cost estimates, which were made with considerable care, seek to illustrate the importance of incidental items when considering public improvements in a city.

Protection by Levees. As we have previously stated, the only means of relief is that and other means for the protection of the low-lying area of this subject is the construction of levees. The work of levee construction in the Mississippi valley is one of the most extensive since the beginning of the present century. The conditions has been the result of the great flood of Mississippi and its tributaries and the fact that the Mississippi and its tributaries are the most fertile and most densely populated in the world. The Mississippi valley is one of the most fertile and most densely populated in the world. The Mississippi valley is one of the most fertile and most densely populated in the world.

The work of levee construction in the Mississippi valley is one of the most extensive since the beginning of the present century. The conditions has been the result of the great flood of Mississippi and its tributaries and the fact that the Mississippi and its tributaries are the most fertile and most densely populated in the world. The Mississippi valley is one of the most fertile and most densely populated in the world.

FLOOD PROTECTION BY CHANNEL IMPROVEMENT 107

TABLE XIV.—PHYSICAL DATA AND SUMMARY OF COST BY ITEMS OF THE TEN INVESTIGATED PROJECTS FOR FLOOD PROTECTION AT COLUMBUS, OHIO

	Units	Proj. No. 1	Proj. No. 2	Proj. No. 3	Proj. No. 4	Proj. No. 5	Proj. No. 6	Proj. No. 7	Proj. No. 8	Proj. No. 9	Proj. No. 10
Total flood capacity.....	C.F.S.	200,000	200,000	200,000	200,000	200,000	200,000	150,000	150,000	150,000	150,000
Capacity, Scioto No. of Sandusky.....	C.F.S.	110,000	110,000	10,000	110,000	110,000	85,500	85,500	85,500	57,000	57,000
Capacity, Scioto Mound to Sandusky.....	C.F.S.	200,000	100,000	100,000	50,000	50,000	50,000	100,000
Capacity, Scioto S. of Mound.....	C.F.S.	200,000	200,000	{ 100,000 }	200,000	200,000	150,000	150,000	100,000	100,000
Capacity Olentangy.....	C.F.S.	90,000	90,000	90,000	90,000	90,000	64,500	64,500	64,500	43,000	43,000
Capacity Gift St. Cutoff.....	C.F.S.	100,000	100,000	100,000	200,000	150,000	100,000	150,000	100,000	100,000	100,000
Capacity Asylum Cutoff.....	C.F.S.	100,000	50,000	50,000
Reservoirs to detain.....	C.F.S.
Preliminary expense.....	Dollars	172,000	165,000	152,400	112,400	113,100	100,900	80,800	71,800	84,900	83,800
Land.....	Dollars	5,038,800	3,983,800	3,232,700	3,614,300	3,107,600	3,751,500	3,088,000	2,657,500	3,613,100	3,039,800
Direct damages.....	Dollars	150,000	211,200	200,000	60,000	60,000	60,000	60,000	60,000	60,000	60,000
Temporary streets and bridges.....	Dollars	78,000	126,000	152,000	52,000	80,000	80,000	46,000	80,000	46,000	60,000
Changes in water lines.....	Dollars	194,000	183,000	118,300	140,400	149,400	12,000	24,400	24,400	12,000	13,200
Changes in sewers.....	Dollars	38,000	124,200	123,400	186,400	86,400	86,400	186,400	86,400	186,400	1,500
Changes in street lighting.....	Dollars	10,000	12,500	12,100	7,000	5,900	5,900	5,900	5,900	4,900	2,900
Excavation.....	Dollars	6,337,000	5,073,000	5,925,000	3,542,000	3,479,500	1,841,500	2,416,500	1,841,500	994,000	1,394,000
Street bridges.....	Dollars	2,767,700	3,009,700	2,615,700	1,828,700	2,655,700	1,445,200	1,289,200	1,463,200	1,199,000	1,468,000
Walls.....	Dollars	977,000	1,383,600	943,000	970,700	970,700	2,119,200	493,200	493,200	2,119,000	72,000
Dams, weirs, slope paving and control gates.....	Dollars	671,700	1,263,200	913,000	583,400	472,200	384,500	418,500	384,500	248,200	992,500
Raising streets and new streets.....	Dollars	48,100	48,100	113,100	48,100	48,100	48,100	48,100	48,100	4,000	4,000
Repairing levees and buildings.....	Dollars	200,000	200,000	200,000
Parks.....	Dollars	345,700	329,900	304,600	224,700	278,800	201,800	161,600	143,600	169,700	167,300
Administration by Commission, 2 per cent.....	Dollars	1,038,900	989,800	913,700	673,900	604,900	604,900	484,500	430,400	509,300	501,800
Engineering and superintending, 6 per cent.....	Dollars	518,500	485,000	457,000	337,100	339,500	302,400	242,300	215,300	284,500	250,900
Interest lost during construction, 3 per cent.....	Dollars
Contingencies and indirect damages.....	Dollars	1,382,400	1,319,700	1,218,500	898,500	905,200	808,600	646,000	574,000	678,900	690,000
..... 5 per cent.....	Dollars	20,737,300	19,798,500	18,273,500	13,479,800	13,236,500	12,063,900	9,690,800	8,609,800	10,183,900	10,014,800
Total.....	Dollars	732,200	729,800	660,100	412,200	412,200	229,000	229,000	229,000	158,000	219,500
Changes in railroads.....	Dollars	1,207,000	1,160,000	1,398,000	977,000	1,120,000	884,000	826,000	860,000	635,000	785,000
Railroad bridges.....	Dollars	92,000	111,300	118,900	61,000	57,400	68,800	66,400	66,200	60,200	22,900
Changes in steel railroads.....	Dollars	173,000	183,500	147,700	90,700	52,600	89,200	80,000	83,500	60,200	40,100
Changes in other public utilities.....	Dollars	44,800	440,700	464,200	323,200	339,900	255,000	262,100	251,800	187,400	207,800
Contingencies, 20 per cent., detailed as above.....	Dollars	2,645,000	2,544,300	2,785,900	2,004,100	2,589,100	1,515,000	1,572,500	1,510,800	1,244,100	1,244,900
Grand Totals.....	Dollars	23,382,300	22,440,800	21,063,900	15,483,700	15,275,600	13,615,900	11,263,300	10,120,600	11,308,000	11,259,700

importance of these factors may be placed in the order named, although to arrange them in order of importance is somewhat akin to placing a relative value upon food and drink.

On the Mississippi there are sedimentary materials that are extremely light and easily eroded by flowing water. Such materials are frequently found in the lower courses of alluvial streams. They require flat slopes in a levee to obviate slipping, which is a frequent cause of levee failure when a flood is of such duration that the levee is thoroughly saturated. There are other localities, more often on the upper waters of the rivers and tributaries, where a mixture of clay and gravel is to be found. This material makes an excellent levee. It stands well upon relatively steep slopes, becomes very hard when dry and the gravel combined makes it highly resistant to erosion both from water flowing on the surface of the embankment and from small seepage courses, holes or cracks in the interior.

The levee foundation is likely to be similar to the material available. Upon the Lower Mississippi bed rock is very deep and the materials overlying it vary in character and stratification. Some of these strata are ill adapted to carrying great weight. Highly porous strata within reach of the river bed often permit the landward flow of the water, frequently causing the formation of "springs" or "boils" inside the levee, which, if sufficiently extensive, destroy the levee through undermining. In the upper tributaries where the depth of alluvial material is likely to be less as well as the height of the levees, the foundation problem is much simplified.

Good practice everywhere necessitates the removal of sod or other substances that through decay would decrease in bulk and thus tend toward the settlement of the embankment or the opening of passages to flowing water. The use of the so-called "muck trench," which tends to cut off the flow beneath the embankment, is well-nigh universal, except where the materials are exceptionally favorable. To some extent sheet piling has been used to cut off highly pervious substrata.

A frequent cause of failure arises through slippage of the rear slopes through saturation when the front of the levee has been wet by the flood for a long time. This is likely to occur when the levee is sufficiently porous, or slopes sufficiently steep so that water of percolation appears above the landward toe of the slope. With a good foundation and a levee properly constructed with good material, such percolation will not occur in sufficient amount to cause serious difficulty, or over an area wide enough to cause a slip and thus endanger the cross-section of the embankment, but in the situations where material is less favorable, and particularly where a levee may be subjected to flood for as long a period as a month or more, very ample cross-sections must be provided to prevent failure. A levee is much less severely tested upon the smaller rivers, say of 1,000 or 2,000 square miles drainage area, where the upper part of the levee may be washed less than 24 hours and the levee may be subjected to flood for less than a week.

In regard to the dimensions of levees, General Chittenden¹ thus summarizes the standard practice on the Mississippi for a levee 20 feet in height:

"Top width 6 feet; river slope 1 on 2, land slope 1 on 2 to a maximum 6 feet below top; back-slope to ground 1 on 4. A trench called a 'work area' is placed underneath and a little in front of the top of the levee. It is 6 feet deep and 6 feet wide on the inside and is filled with the best material available. Levee slopes are graded over as heavily as possible. Consideration of economy suggests use of material nearest any at hand when it is of inferior quality."

Levees more elevated in section are constructed primarily upon the tributaries of the Mississippi where in general the levee heights are less. The material is better and the levees are subjected to flood for a shorter time. Here the heights will generally range from 6 to 15 feet, top width 6 to 10 feet and sometimes side slopes, inside and outside, equivalent to about 3 on 1.

During the Civil War on the Tennesse and Mobile Rivers it

¹Fort Levee, International Engineering Congress, Vol. 1, p. 11, of International Congress Levees, U. S. Army, 1900.

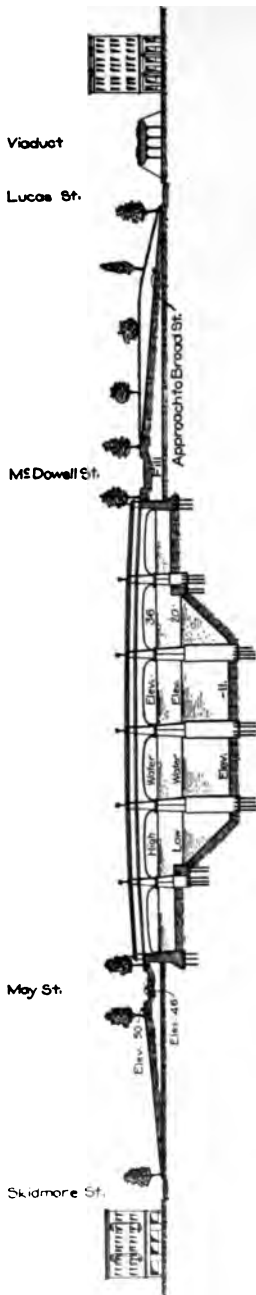

FIG 28.—Section of auxiliary channel at Broad St., between Skidmore and Lucas Sts., Columbus. A proposed new flood channel illustrating the possibility of combining usefulness with beauty. The spoil banks not only form levees but they can be utilized for park purposes.

1913, the levees except where overtopped stood exceptionally well, some of them as slender as 5 feet top width and side slopes steeper than 1 on 2. The levee materials and the foundations were exceptionally good, however.

It sometimes happens that very ample cross-sections can be secured at no added cost. A typical example is found in the project for the relief of Columbus, Ohio, where a short auxiliary channel was proposed to be cut through the West side of the city. The proposed channel was partly formed by excavation and partly by levees. The excavation greatly exceeded the embankment and as the immediate banks of the river made the cheapest place for the disposal of the surplus excavation, it was practicable to build levees with 100 feet top width and a freeboard of 10 feet under maximum flood conditions. This plan lent itself very effectively to a scheme for the remodeling of the street system connecting the various principal sections of the city, it being proposed to utilize the levee tops for a boulevard system.

the Upper Mississippi

low levees are required, much of the work is done by floating-dipper dredges. Where the levees are low it is sometimes necessary to excavate more material to float the dredge than is required in the levee. Therefore, the opportunity is offered for ample cross-sections and heights. In many cases it is economy to construct in this way because the unit cost of dipper dredging is very low.

Levee Freeboard.—No levee can be considered safe if the water may reach to a plane level with its top; for safety from wave action alone a surplus of not less than 2 or 3 feet is needed. This will depend upon the clear length of sweep for the wind over the water surface. The question as to how much freeboard should be provided is important from both the standpoints of safety and cost. A 5-foot addition to a 15-foot levee will increase the amount of earthwork about 75 per cent.

In the construction of levees for the protection of agricultural lands, a minimum of freeboard is generally adopted, in fact many levees exist that are known to be even lower than the maximum flood expectancy. The reclamation of agricultural land is usually a matter of balancing costs for relief against prospective flood losses, particularly where danger to life is not involved. In such cases it might be economy to lose an occasional crop and suffer an occasional damage to the levee system, rather than to provide against the probable maximum flood of the future, with a factor of safety. In a case like this, a large margin between the flood and the top of the embankment may not be justified.

The problem is different, however, in the protection of a city where failure may result in large loss of life and great damage to valuable property. In this case after the maximum flood has been estimated, an allowance is justified covering not only wave action, but also covering a margin for contingencies both in the occurrence of a larger flood than expected, and also by reason of the likelihood for decreased channel capacity which sometimes occurs due to the collection of drift against the bridges or through ice jams. The circumstances will dictate the justifiable ex-

penditure for this purpose, and will somewhat depend upon the liberality with which the maximum flood has been computed. Assuming, however, a liberal allowance for the future, 3 feet of freeboard may be regarded as a minimum; 5 feet may be desirable and certain circumstances such as a surplus of available material may justify even greater freeboard.

In the adoption of a minimum freeboard it does not follow that a greater freeboard on the same levee system



FIG. 29.—Flood debris above a viaduct. (*Courtesy of the Southern Railway.*) This illustrates the importance of a factor of safety in the design of openings and embankments.

cannot be used where it is practicable and not unduly expensive. Thus in the construction of levees in a large city it frequently will be found that the elevation of railroad tracks and of streets is accompanied by much embarrassment and damage to adjacent property for a considerable distance from the river. A case is in mind, in which to change the elevation of a railroad crossing would have involved a change in grade for a large railway terminal.

It is believed to be practicable even when adopting a 5-foot freeboard, to cut the freeboard down to a lesser

amount, say 3 feet, at certain places where to raise tracks, streets or bridges would require an excessive expenditure. Relatively short lengths, it is believed, can be effectively protected through temporary structures during a great flood, particularly if provision is made to facilitate a good closure. A subway through which passes a street railway is thus protected in the levee system at Cairo, Ill., and the same principle has been utilized in numerous places elsewhere.

No one who has seen a levee in a great flood would minimize the importance of a reasonable freeboard.

Limiting Velocities.—In the design of channel improvement projects, it is necessary always to bear in mind that while increased velocities tend to decrease the cross-section necessary to carry a flood, and consequently tend to reduce the gage height, there is a limit beyond which an increase in velocity will, through erosion, destroy the works created for relief. Therefore, the control of velocities, or the protection against excessive velocities is something that always must be kept in mind.

The materials constituting stream beds, the alluvial deposits in river valleys and, therefore, the materials available for levee construction, vary widely in their ability to withstand erosion. Table XV is the result of investigations by Dubuat, purporting to show the velocities beyond which certain materials will be eroded by flowing water. This table is taken from the well-known work on hydraulics by Ganguillet and Kutter. The table is accompanied by the remark, "the above figures appear to us rather too small than too large, and thus err on the side of safety."

It will be noted that the table shows bottom velocity, average velocity, and maximum surface velocity, the first of which only is of significance in the matter of erosion. The figures presented refer to the velocities just insufficient to move the respective materials lying on the bottom of a channel, rather than velocities dangerous through the rapidity with which erosion would take place. This especially in rivers is a quite different matter. In this con-

TABLE XV.—**VELOCITY AND GRAIN WHICH EROSION BEGINS TO TAKE PLACE FROM THE ACTION OF GRAVITY** as published by Ganguillet and Kutter

GRAIN WHICH EROSION BEGINS TO TAKE PLACE FROM THE ACTION OF GRAVITY	Bottom velocity feet per second	Mean velocity feet per second	MAXIMUM SURFACE VELOCITY feet per second
River mud, <i>specific gravity</i> = 2.64	0.25	0.33	0.40
Silt, <i>specific gravity</i> = 2.55	0.35	0.46	0.55
Clay, <i>specific gravity</i> = 2.55	0.50	0.66	0.79
Sand, <i>specific gravity</i> = 2.55	0.60	0.79	0.95
Coarse gravel, <i>specific gravity</i> = 3.36	0.70	0.92	1.10
Sand, <i>specific gravity</i> = 2.55	1.07	1.40	1.69
Gravel	2.00	2.62	3.15
Round gravel, <i>specific gravity</i> = 2.65	2.13	2.79	3.36
Coarse gravel, <i>specific gravity</i> = 3.00	3.00	3.93	4.73
Angular gravel, <i>specific gravity</i> = 2.25	3.23	4.23	5.09
Angular gravel, <i>specific gravity</i> = 2.50	4.00	5.24	6.30
Soft slate, <i>specific gravity</i> = 2.70	5.00	6.55	7.86
Stratified rock, <i>specific gravity</i> = 2.70	6.00	7.86	9.43
Hard rock, <i>specific gravity</i> = 2.70	10.00	13.12	15.75

In connection it should be realized that all streams are transporting material of various kinds to a greater or less extent, depending upon the nature of the materials over which they flow, and the velocity. In actual practice it is found that canal cross sections are sufficiently permanent for practical purposes at average velocities considerably higher than those quoted in Table XV. According to Wilson,¹ the following may be regarded as safe velocities for irrigation canals:

Light sand, <i>specific gravity</i> = 2.55	2.3 to 2.4 feet per second
Ordinary sand, fine sandy loam, <i>specific gravity</i> = 2.55	3.0 to 3.5 feet per second
Firm gravel, <i>specific gravity</i> = 3.36, or rock, <i>specific gravity</i> = 2.70	5.0 to 7.0 feet per second

In the larger streams it has been observed that no damage is done to banks or levees under velocities very materially greater than would be considered safe in canals. The fact is doubtless in the fact that the depth of a river is not a function of the velocity of the water. "Irrigation Engineering," H. M. Wilson, C. E.

gradually decreases from the thread of a stream to the edge of the water, whereas in artificial channels, the bottom is usually flat with relatively steep slopes near the banks. For this reason the highest velocities in rivers are so located that erosion does a minimum of damage. In fact, upon most rivers, there is considerable midstream erosion during flood, and in the light soils forming the bed of such Southwestern streams as the Colorado, the bed of the stream may be eroded to great depths and replaced with the erosion



FIG. 30.—The high velocities produced tangled masses of wreckage.—Dayton flood.

from upstream upon the recession of the flood, without great effect upon the banks.

Numerous accurate measurements upon the Mississippi and Missouri Rivers have indicated average cross-sectional velocities of from 7 to 8 feet per second at the higher stages of water. No doubt velocities very much higher exist at certain places even in these rivers of very moderate fall.

In the great flood of 1913 upon the Scioto River in Ohio, an opportunity was afforded to study the relation between velocity and erosion, as follows:

Immediately above the Columbus water-storage reservoir, the average cross-sectional velocities ranged from $8\frac{1}{2}$ to 9 feet per second. In this part of the stream rock lies

only a short distance below the surface, and is overlaid with sand and gravel in the stream bed, and on the banks there is a rather thin soil of gravelly clay. The washing produced by the above velocities was not great.

Macadam road surfaces were usually washed away and, curiously enough, stone fences were in many places thrown down, while soil where protected by sod was eroded only in exceptional instances.



FIG. 31.—This wreck was caused by an insufficient bridge opening. A head of about seven feet was created and the excessive velocities undermined the piers though resting upon piles.

In the city of Columbus the river makes a detour about 2 miles in length, gradually turning nearly 180° . In this ox-bow Prof. Frank H. Eno observed surface velocities ranging from 9 to 13.5 feet. The bed and banks of the river, and the levees in this vicinity consist of a "gravelly clay" with more or less pure sand and gravel in the stream bed. The cutting in the stream bed was sufficient to undermine the piers of nearly all the bridges of which there were a number, even although resting upon piles. In certain

places holes were cut 20 to 30 feet deep. Cutting upon the banks was very moderate, although in evidence at certain places where the walls of buildings were undermined.

The levees were located upon the inside of the curve, and were practically uninjured except where they were overtopped. The face of the levee was cut in only one instance, and this occurred near Mound Street where the river turns sharply at an angle of about 60°, with the levee on the outside of the curve. At this place the levee was cut away and destroyed. The average cross-sectional velocity at this place was about 8½ feet per second.

Upon the Miami River during the same flood, the question of erosion has been very carefully studied by the Morgan Engineering Co. in connection with flood relief for Dayton and the Miami Valley. The Miami and several of its tributaries were studied in the light of estimated flood apex rates, and the surveyed cross-sections through which the flood passed. The soil in general is quite similar to that upon the Scioto, consisting principally of gravel and sand with an admixture of clay where it has not recently been washed.

In general it was found, where the average cross-sectional velocities ranged from 11 to 14 feet per second, that washing occurred only in the vicinity of obstructions such as bridge piers, etc. Where the velocities ranged between 14 and 16 feet, serious washing occurred.

Natural soils and available levee materials are quite variable, and therefore the limiting velocities in any particular improvement must largely be governed by experience in the locality and, therefore, in planning works for flood relief the opportunity should not be neglected to make the fullest use of past experience. If a great flood is sufficiently recent so that its effect can be observed, it will furnish the best evidence as to practicable velocities.

Velocity Control.—In the design of channel improvements, if the resulting velocities exceed safe figures for the material in which channels are cut, or of which levees can

be built, then means must be provided for checking the velocities, or the banks must be protected against wash.

In most channel improvements it is economical at certain places, as for instance, at bridge openings where the channel is especially contracted, to protect the banks against wash in some artificial manner as by riprap or pavement.

The banks below the low-water plane may be protected by brush mattresses or fascines. This practice has been quite extensively followed upon the Lower Mississippi. Banks above high water must be protected by a less perishable material, and for this purpose stone pavement or stone riprap has very largely been used, especially in the protection of embankments adjacent to bridges. Reinforced concrete lately has come to be in use for bank protection, both above and below the low-water plane.

Perhaps the best protection for ordinary levee surfaces is found in a good, tenacious sod. One of the striking lessons of the recent Ohio floods is the protection afforded by bluegrass in resisting erosion.

In certain cases where the velocities would be too great for ordinary bank protection, or where the expense would be excessive in the protection of river bed and banks, it will be found advisable to check the velocity by concentrating the fall through the construction of submerged weirs or dams where especial protection against erosion can be secured. Modern reinforced-concrete bridges sometimes offer the opportunity to construct submerged weirs to accomplish this purpose at a minimum of cost.

In the use of the submerged weir, it will be wise before planning extensive works, to study the effect where similar weirs actually have been built, for the hydraulics of this type of structure is not well developed theoretically.

Significance of Hydraulic Formulæ.—The formulæ pertaining to water in motion, although founded upon theoretical considerations, are empirical in their nature; that is, they are designed to fit observed occurrences either in
 * in the field. Theory has been depended
 . is necessary to reason from the con-

ditions pertaining in an actual experiment, to results under different conditions, and like most excursions of this kind



FIG. 32.—Although the velocities in the 1913 Ohio flood were sufficient to overturn tombstones, yet the sod prevented erosion.



FIG. 33—This illustrates the value of sod in the prevention of erosion. Note the stones in the eroded flower bed that have been washed from the macadam roads.

the shorter the travel the more dependable will be the result. Without theory which serves to connect one ex-

periment with another, practical experience would be nearly useless, for none of the practical hydraulic problems are exactly alike, and no experience could possibly be long enough to accomplish anything useful without the proper use of theory.

The man of technical education, however small his experience, realizes that in the consideration of channel improvements, for instance, the amount of work that must be done, and hence the cost of the improvement, is largely bound up in the hydraulic formulæ or the calculations



FIG. 14.—Illustrating the limiting power of snow under flow velocities sufficient to destroy the snowdrifts.

through which the capacity of the channel is determined. Right here is the stumbling block of the inexperienced investigator. Hydraulic formulæ are constructed for the purpose of reasoning from a known result under certain conditions, to a result under changed conditions. It is of the utmost importance that in this line of reasoning the conditions shall be changed as little as possible and, therefore, flow coefficients secured from streams other than the one under consideration, or under circumstances different from those being considered, should only be used when no other information can be secured. The best

possible information usually is to be found upon the stream under examination, providing the time and money are available for observation and study. No flow data from extraneous sources can possibly supplant an observed profile under conditions of known flow rate through determinable cross-sections.

To reason thus from one profile to a slightly different profile, or from one flow to a slightly different flow, has the advantage over the application of general coefficients,



FIG. 25.—Rock erosion below Scioto River storage dam.

Many of the rocks in the large pile extending across the left corner of the picture were eroded from their natural bed, near the toe of the dam, by the water falling over the dam during the flood of March, 1913, and deposited as shown.

that it takes into account a multitude of minute factors and irregularities that by no possibility can be compressed into a formula. Theory will be of the greatest use, however, to make the steps properly, even though they may be short steps.

It is not to be expected that the laymen will appreciate the necessity for study and observation upon the particular stream in question even where a large problem is involved. Engineers in general, whether or not skilled in hydraulics, can greatly aid the solution of these problems by assisting

the laymen to appreciate the importance of study where the benefits of investigation promise to be great enough to warrant the time involved.

River Flow.—A number of formulæ have been proposed and used, expressive of the relations between the velocity of flow in rivers and channels, and the factors that tend to promote and retard velocity. The factors most commonly considered are the slope or fall, the degree of channel roughness as tending to retard the flow of the water, and the relation between the surface subjected to friction and the total cross-section of the flowing water. Experience lines up with theory that the greater the mean depth, the more easily, and, therefore, rapidly the water will flow under a given slope.

In most problems of river hydraulics, it is sufficiently accurate to assume that the velocity will vary as the square root of the slope, and also as the square root of the hydraulic radius or hydraulic mean depth, which, in hydraulic formulæ, is the area of the stream cross-section divided by the width measured along the stream bottom and sides. In a rectangular channel this would be the cross-sectional area divided by the width plus twice the depth. In the consideration of rivers where the width is usually many times the depth, it is sufficiently accurate to use the mean depth or average depth interchangeably with the hydraulic radius of the ordinary formula, for in large rivers there is no important difference between width and wetted perimeter. At least it is well within the limit of error involved, and to use mean depth greatly simplifies calculation. The relations of velocity, depth and slope are most commonly expressed by the well-known Chezy formula

$$v = c \sqrt{rs}$$

in which v is velocity in feet per second, r is hydraulic radius or mean depth, s is slope, and c is a coefficient expressive of the roughness of the stream, and other fac-

terminated for a particular problem
 a stream often under condi-

tions very similar to those of the problem in hand. For the solution of problems where this is not practicable, it is necessary to go to experimental data, and where this is necessary, most engineers utilize the data presented in the well-known work of Ganguillet and Kutter, which has been translated into English by Rudolph Hering, and John C. Trautwine, Jr. Although the so-called "Kutter formula" which attempts to establish a relation between the factor c and the roughness, and the other factors that affect it, is extremely complicated, its use is simplified by tables and diagrams well understood by engineers and the wealth of data quoted by Ganguillet and Kutter, and the numerous experiments supplementing this work from time to time have made the formula extremely valuable. Doubtless the formula has its limitations, and some of the data upon which it is based have been criticised by hydraulicians, but the results obtained by its use are well within the ordinary limits of hydraulic accuracy, providing that the departure from observed occurrences is not too great.

TABLE XVI.—TABLE OF n FOR KUTTER'S FORMULA
(Prepared by R. E. Horton)

Surfaces	Perfect	Good	Fair	Bad
Uncoated cast-iron pipe	0.012	0.013	0.014	0.015
Coated cast-iron pipe	0.011	0.012*	0.013*	
Commercial wrought-iron pipe, black	0.012	0.013	0.014	0.015
Commercial wrought-iron pipe, galvanized	0.013	0.014	0.015	0.017
Smooth brass and glass pipe	0.009	0.010	0.011	0.013
Smooth lockbar and welded "OD" pipe	0.010	0.011*	0.013*	
Riveted and spiral steel pipe	0.013	0.015*	0.017*	
Vitrified sewer pipe	0.010 0.011	0.013*	0.015	0.017
Glazed brickwork	0.011	0.012	0.013*	0.015
Brick in cement mortar; brick sewers	0.012	0.013	0.015*	0.017
Neat cement surfaces	0.010	0.011	0.012	0.013
Cement mortar surfaces	0.011	0.012	0.013*	0.015
Concrete pipe	0.012	0.013	0.015	0.016
Wood-stave pipe	0.010	0.011	0.012	0.013

* Values commonly used in designing.
From *Engineering News*, Feb. 24, 1916, p. 373.

TABLE XVI.—Continued

Surfaces	Perfect	Good	Fair	Bad
Plank flumes:				
Planed.....	0.010	0.012*	0.013	0.014
Unplaned.....	0.011	0.013*	0.014	0.015
With battens.....	0.012	0.015*	0.016	
Concrete-lined channels.....	0.012	0.014*	0.016*	0.018
Cement-rubble surface.....	0.017	0.020	0.025	0.030
Dry-rubble surface.....	0.025	0.030	0.033	0.035
Dressed-ashlar surface.....	0.013	0.014	0.015	0.017
Semicircular metal flumes, smooth.....	0.011	0.012	0.013	0.015
Semicircular metal flumes, corrugated..	0.0225	0.025	0.0275	0.030
Canals and ditches:				
Earth, straight and uniform.....	0.017	0.020	0.0225*	0.025
Rock cuts, smooth and uniform.....	0.025	0.030	0.033*	0.035
Rock cuts, jagged and irregular.....	0.035	0.040	0.045	
Winding sluggish canals.....	0.0225	0.025*	0.0275	0.030
Dredged earth canals.....	0.025	0.0275*	0.030	0.033
Canals with rough stony beds, weeds on earth banks.....	0.025	0.030	0.035*	0.040
Earth bottom, rubble sides.....	0.028	0.030*	0.033*	0.035
Natural stream channels:				
1. Clean, straight bank, full stage, no rifts or deep pools.....	0.025	0.0275	0.030	0.033
2. Same as (1), but some weeds and stones.....	0.030	0.033	0.035	0.040
3. Winding, some pools and shoals, clean.....	0.035	0.040	0.045	0.050
4. Same as (3), lower stages, more inef- fective slope and sections.....	0.040	0.045	0.050	0.055
5. Same as (3), some weeds and stones..	0.033	0.035	0.040	0.045
6. Same as (4), stony sections.....	0.045	0.050	0.055	0.060
7. Sluggish river reaches, rather weedy or with deep pools.....	0.050	0.060	0.070	0.080
8. Very weedy reaches.....	0.075	0.100	0.125	0.150

* Values commonly used in designing.

From *Engineering News*, Feb. 24, 1916, p. 373.

Irregular Channels.—Where irregular channels are under consideration, the chance for error is large unless there is an opportunity to observe the behavior under at least some of the flow conditions of the channel in question.

of the curves and the bridge and building
iculary where a river flows through a

city, has a very important bearing upon the relation between velocity and slope. Under conditions such as these, no data can displace observations on the stream in question.

In the ordinary river channels, particularly if a long reach of river is under consideration involving all kinds of bends and ordinary obstructions, the experimental data from other similar rivers can be used to advantage. Tables XVII and XVIII show certain flow coefficients observed upon the Illinois and Scioto Rivers during recent flood investigations upon these streams. They refer to rivers in flood under the high velocities incident to a bankful stage, and stages of water where the banks are overflowed.

Where rivers forsake their natural channels and overflow large areas of adjacent land, flow conditions are very materially altered. If the area of flood cross-section upon land bears an important relation to the total, it must be separately treated in estimates of flow or gage height under a given flow, for the impediment to flow upon land, unless it be cleared of vegetation and other obstructions, bears little relation to the conditions in the ordinary stream bed.

Table XVII summarizes certain conditions as disclosed by investigation upon the Illinois River during a great flood, in which the flow upon the bottom lands was an important part of the total flow. In this investigation it was observed that the character of the bottom land, particularly as to the extent of the wooded areas, had an important effect upon the velocity of the flowing water. The table is presented more for the purpose of emphasizing the important differences between channel flow and land flow, rather than to present data whose scientific accuracy would warrant general use.

The study of the floods upon this stream further emphasizes the importance of actual observation where practical, in the consideration of such complicated flows as those occurring in the reaches of the river where the bottom lands were partly reclaimed by farm levee districts. In

RELIEF FROM FLOODS

TABLE XVII.—VALUING IN FLOW FORMULA DURING APRIL OF MEASURED FLOOD OF 1904 AT VARIOUS PLACES ON ILLINOIS RIVER

Date	Length, feet	Total valley			Channel section			Land section			Ratio of land flow to total flow, per cent.	
		Length, feet	Average flow, c.f.s.	Average section, square feet	Average depth, feet	Average section, square feet	Average depth, feet	Average section, square feet	Average depth, feet	Resulting value of c		
Apr. 6	226,000	9.3	122,000	114,000	8.6	31,000	17.6	82,000	82,000	7.2	29,000	28
Apr. 6	192,000	6.4	112,000	130,000	7.1	27,000	14.6	62,000	103,850	0.2	51,300	33
Apr. 6	410,000	16.7	118,000	122,000	7.9	29,000	16.1	72,000	93,000	6.7	46,300	31
Apr. 4	104,200	4.1	96,000	218,000	10.9	21,070	16.9	42,300	196,280	10.8	82,700	16
Apr. 3	174,000	3.5	80,000	189,000	12.6	29,200	16.4	41,000	169,400	12.1	43,400	17
Mar. 24	39,000	3.6	81,000	71,000	11.6	23,000	17.6	82,000	51,100	10.1	-1,000	
Apr. 4	308,000	10.6	80,000	183,000	11.4	20,000	10.0	43,000	163,000	11.0	45,500	13
Apr. 4	608,000	27.3	103,000	106,000	9.6	24,000	16.6	51,000	134,000	9.0	52,000	21

Note: c refers to Chazy's formula $v = c\sqrt{ra}$.

FLOOD PROTECTION BY CHANNEL IMPROVEMENT 127

TABLE XVIII.—OBSERVED FLOW COEFFICIENTS AT FLOOD STAGES

	Length of reach, miles	Average velocity, feet per second	c in $v =$ $c \sqrt{rs}$	n , Kutter's formula
Scioto River near Circleville, Ohio: bank full flood; moderate curvature; few obstructions.....	13.0	82	0.0275
Scioto River in Columbus: principally in curve about 2 miles in length; 9 bridges; banks fairly uniform; flood of Jan. 2, 1916	4.0	1.8 to 6.5	49	0.0560
Ditto, Jan. 3, 1916.....	4.0	2.1 to 5.7	57	0.0480
Ditto, flood of July, 1915	1.2	3.8 to 6.6	54	0.0570
Ditto, flood of March, 1913	1.0	6.4 to 8.2	53	0.0550
Scioto River above Columbus: in flood of 1913; rocky banks covered with trees and brush; about two-thirds of flood cross-section in bed of stream; near Powell Road.....	0.6	9.6	71	0.0350
Below Powell Road	1.0	8.9	59	0.0440
Near Dublin Bridge.....	0.5	8.5	54	0.0460
Illinois River between Peoria and Grafton: in flood at "bank full" stage of water; average of 23 observations.....	163.0	1.2 to 2.6	103	0.0257
Ditto, flood covering bottom lands; 73 per cent. of total section on land; average mean depth 9.5 feet.....	163.0	38	

long reaches of the stream, the flow prism of the flood was frequently enlarging and contracting on account of more or less isolated drainage districts, and even where the bottom lands were nearly all leveed the same thing occurred on account of the enlargements of the flood prism at the junction with tributaries large and small. No theoretical study could have displaced observations upon the behavior of known floods through certain parts of this river valley, and with the behavior under the conditions of a known flood determined, the flood heights for floods of different flow magnitude could be determined with an accuracy not otherwise possible.

CHAPTER VII

FLOOD PREVENTION BY WATER STORAGE

Having considered the means for flood protection, it remains to consider the works for flood prevention. At present, water storage is the only available means for flood prevention that can be called a practicable remedy under the conditions generally prevailing in this country. On the pages which follow, it will be the endeavor to outline the general principles pertaining to flood storage, the situations to which it is applicable, and the incidental benefits that usually accompany this type of flood relief.

Distribution of Stream Flow.—A glance at the rainfall map of the United States plainly indicates the principal source of the rainfall in the South Atlantic, the Gulf of Mexico and the Pacific Ocean, the inland travel of the moisture-laden air, and the gradual reduction of the annual depth of rainfall progressively from the coast. Thus, from Virginia to Louisiana the mean rainfall will generally vary from 50 to 60 inches; from Maine to Arkansas 40 to 50 inches; and from Lake Champlain to Missouri, Iowa and Wisconsin, 30 to 40 inches. Westward from a north and south line through eastern Nebraska where the mean rainfall is 30 inches, the rainfall gradually diminishes to about 10 inches at the base of the Rocky Mountains. Similar gradations of rainfall occur upon the Pacific coast, but here the rainfall is largely influenced by the high mountains of the coast and the Sierra Nevada ranges. The mountains have a similar effect in west North Carolina and east Tennessee, the rainfall being excessive on the coast slope of the range.

The rainfall is reflected in the stream flow. Speaking generally, 15 to 20 inches will cover the losses including evaporation and the consumption of vegetation. There-

fore, roughly speaking, the rainfall less 15 or 20 inches will approximate the runoff of the streams. Thus, in the northern United States, with 40 to 50 inches in rainfall, about one-half is delivered again to the sea. In the northern Middle West where the rainfall is 30 to 40 inches, the streams generally deliver 10 to 20 inches. In the semi-arid regions of western Texas, eastern Colorado, and including a strip running north to the Canadian boundary, where the rainfall varies from 10 to 20 inches, the annual runoff upon many of the streams is less than an inch in the southern portion, and from 2 to 5 inches in the northern part of the strip. Between the Continental Divide and the Sierra Nevada range the rainfall and stream flow is largely affected by the lofty mountain peaks which exert a powerful precipitating influence upon relatively small areas. This results in local areas of heavy precipitation and very large areas of desert.

Seasonal Irregularities.—Everyone appreciates the great irregularity of the rainfall, from day to day and from month to month. The stream flow is more regular, as it is influenced by the storage upon the ground and the storage within the grains of the soil. Through these natural storage facilities, the ordinary storms are fed to the streams very gradually, particularly in the growing season. In the barren season of the year from November until April, in the Northern States, the underground storage may be quite destroyed, and at such seasons particularly, and to a less extent also in the summer, the capacity of both the underground and surface storage reservoirs may be, and frequently are, overtaxed and a freshet results.

The magnitude of the freshet obviously depends upon the rainstorm, and also the natural facilities for storage have a very important influence. Thus, upon the St. Lawrence River at the outlet of the Great Lakes, the seasonal variation in flow is scarcely noticeable. A similar effect is observed wherever lake areas bear important relation to the total watershed. On the lower peninsula of Michigan, the underground reservoirs of sand and gravel exert an impor-

tant influence, and although the stream flow is much less uniform than upon the St. Lawrence River, the streams are much less flashy than the rivers of the Ohio watershed where natural storage is largely absent both above and below ground. The flood problem is most acute where the natural facilities for storage are absent.

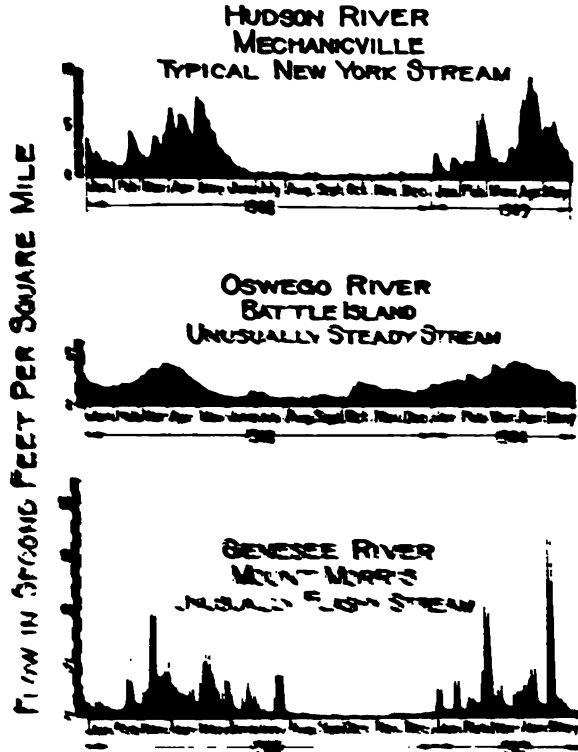

FIGURE 10. Hydrographs showing irregular fluctuations in flow in New York State streams.
 Courtesy of U. S. Army Corps of Engineers

...the stream flow may vary ... storage ...

that the flood reservoir serves a useful purpose in storing the freshets, and spending it at a rate within the capacity of the channels.

Incidental Storage.—It readily will be appreciated that if a reservoir is useful for flood relief, it must be in such a state of emptiness immediately before the appearance of the flood, that the freshet can be stored, or a sufficient amount of it, to reduce the flow to manageable limits. It has been observed that all works for water storage have a more or less beneficial influence upon floods. Conversely, it is an attractive possibility to attempt to do more than relieve floods with the reservoirs built for this purpose, by utilizing them for water conservation in the interests of water supply, water power, navigation, sanitation and a general better distribution of the stream flow. The Germans and the Austrians who have recently carried out extensive water conservation works have found it practicable to combine several of these purposes in some of the reservoirs that they have built.

These uses are often more or less conflicting, thus, a flood reservoir must be empty, ready to catch a flood at any time that the flood may come. In municipal water supply it is the endeavor to keep the reservoir as nearly full as possible at all times in order to tide over a period of drouth. The water stored for irrigation is used during a few months when the crop is developing, whereas a water-power project would desirably regulate the water in accordance with the demand for power. Navigation is most benefited when storage is drawn upon entirely within the season of minimum gage heights. Special circumstances may make it possible for one or more incidental uses to be properly appurtenant to flood relief, and in outlining works for flood prevention, it is proper to test the remedies in order that no incidental advantage may be overlooked.

Storage for Floods.—It is evident that in the consideration of flood storage, there must be known the rates of flood flow and the periods of time through which various rates prevail; in other words, there must be a hydrograph

of the flow and time relation. With this information, it is a matter of arithmetic to determine the amount of storage that will be required to reduce any given flood to any desired amount. In this problem, apex rates are secondary in im-

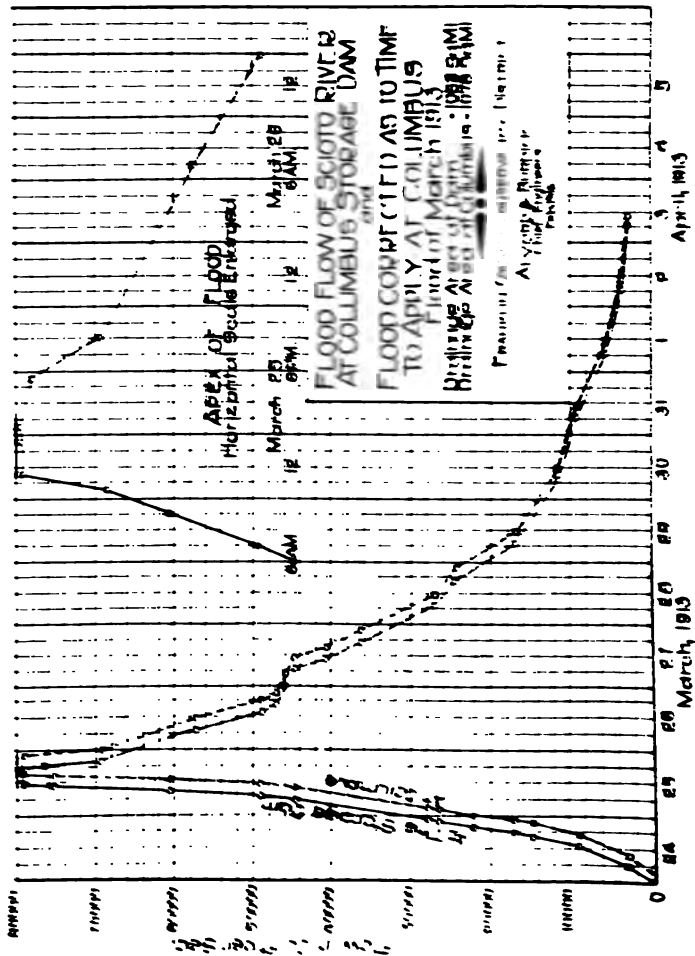

FIG. 37.

portance. It is bulk of flood water and a given amount that governs the amount of storage. In Fig. 37 we see the hydrograph of the Scioto River at the Columbus dam of March, 1913. At this time the drainage

area is 1,053 square miles. Fig. 38 shows in diagrammatic and tabular form, the amount of storage that would be required to reduce the flood to various smaller rates of flow. The storage is expressed in acre-feet. The table shows the number of days in which the reservoir would be filling and emptying.

Flood Rate Reduced to (Sec. ft)	Percent Reduction Flood Rate	Acre Feet of Storage Required	Flow at which Reservoir should begin to fill (Sec. ft)	Length of time filling (Days)	Length of time emptying (Days)	Length of time filling and emptying (Days)
60,000	25%	20,000	60,000	$\frac{1}{2}$	$\frac{2}{3}$	$1\frac{1}{2}$
50,000	37%	36,000	50,000	$1\frac{1}{2}$	$1\frac{1}{2}$	3
40,000	50%	74,000	40,000	$2\frac{1}{4}$	$2\frac{1}{2}$	$4\frac{1}{2}$
30,000	62%	125,000	30,000	$3\frac{1}{2}$	4	$7\frac{1}{2}$

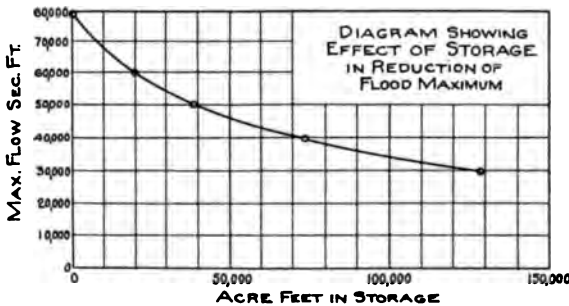

FIG. 38.—Table showing capacities required to reduce maximum flood rate of 1913 (79,600 sec. ft.) to various other maximum rates based on flood measurements at Water Works storage dam, Columbus, Ohio.

The above calculation is based upon the theory that the storage would all be used precisely at the moment when it would have the fullest effect, taking into consideration the whole period of the flood. No storage reservoir could thus be 100 per cent. efficient. This desideratum can only be approximated, as hereinafter explained. The figures show the ultimate possibility.

The computation indicates that to have reduced the flood 50 per cent. would have required storage to the equivalent

of 15 inches of depth over the whole watershed at a storage equivalent to about one-third of the annual rainfall. Stored in another way, the storage would be equivalent to about 25 per cent of the 15 inches of rain water fed up to the flood apex in the great flood flood.

Ohio River.—In order to provide a visual comparison between treatment small and large watersheds, we have plotted on the same scale the great flood upon the Susquehanna River at the maximum storage limit of 1,000 square miles and the greatest flood in record of the Ohio River at Cincinnati.

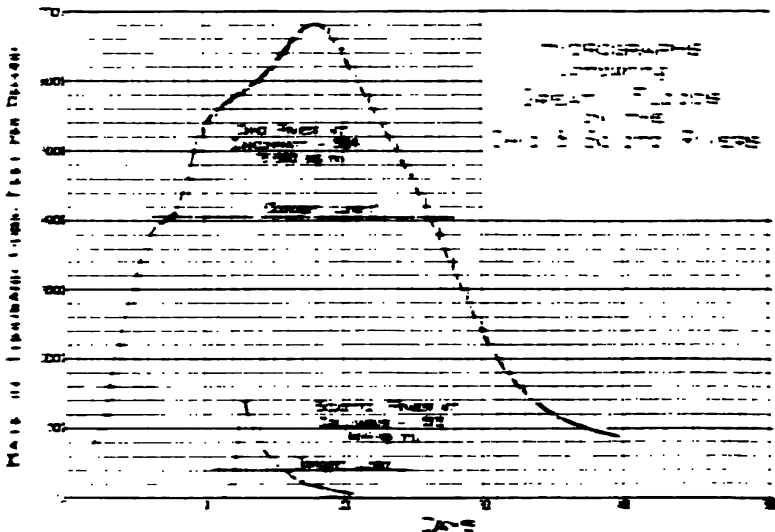

Fig. 10

which has a drainage area of 1,000 square miles. The flood of 1913, which began on the first of March, 1913, and the flood of 1914, which began on the first of April, 1914, were the two greatest floods in the great flood of 1913. The flood of 1913 reached a peak rate of 1,000,000,000 cubic feet per hour at the apex of the flood wave. The flood of 1914 reached a peak rate of 200,000,000 cubic feet per hour at the apex of the flood wave. The flood of 1913 was the greatest flood in the great flood of 1913. The flood of 1914 was the second greatest flood in the great flood of 1913. The flood of 1913 was the greatest flood in the great flood of 1913. The flood of 1914 was the second greatest flood in the great flood of 1913.

on it is stated that the total amount of water that passed over the dam was estimated at about 1,000,000,000.

The relative amount of storage for a given effect upon the Scioto and Ohio Rivers is illustrated on Fig. 40. In this diagram the data above presented for the Scioto has been used, but the flood reduction is expressed in per cent. of the apex flood rate. From the hydrograph of the great Ohio flood, similar information has been computed which is shown on the diagram.

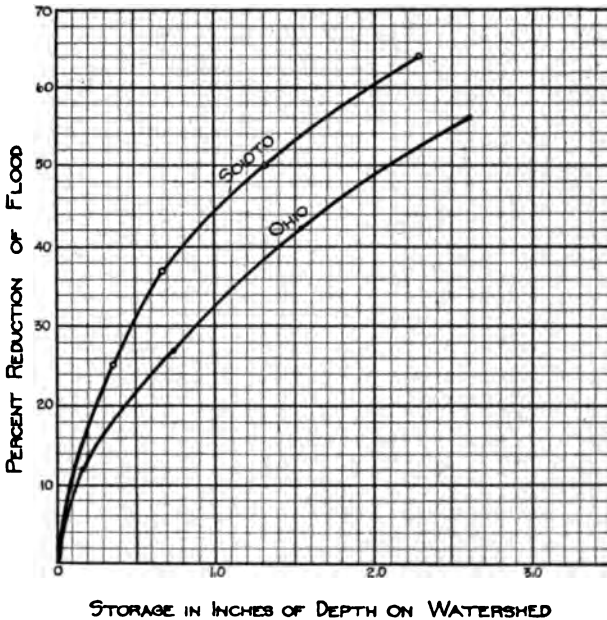

FIG. 40.—Diagram showing relation between amount of storage and flood reduction on Ohio River at Cincinnati (75,800 sq. mi.), and Scioto River at Columbus storage dam (1,053 sq. mi.).

The Scioto flood was above the danger line for a period of about $3\frac{1}{2}$ days as compared to 19 days upon the Ohio, and the apex rate per square mile at Columbus was a little less than ten times the apex rate on the Ohio. It will be observed, however, that the smaller drainage area at Columbus produces a more slender hydrograph, and as would be expected, proportionately larger storage areas are required for a given effect upon the Ohio. Thus referring again to Fig. 40, it is indicated that a 50 per cent. flood reduction upon the Scioto would require a storage of 1.3

inches upon the watershed as compared to 2.1 inches for the Ohio, an increase of 60 per cent., or stated in another way, 2 inches of storage would reduce the flood about 48 per cent. upon the Ohio and 60 per cent. upon the Scioto.

These relations are applicable only to these particular storms on these particular rivers, but they probably typify the great storms more or less accurately. The data, however, cannot be extended to other rivers, for it is obvious that

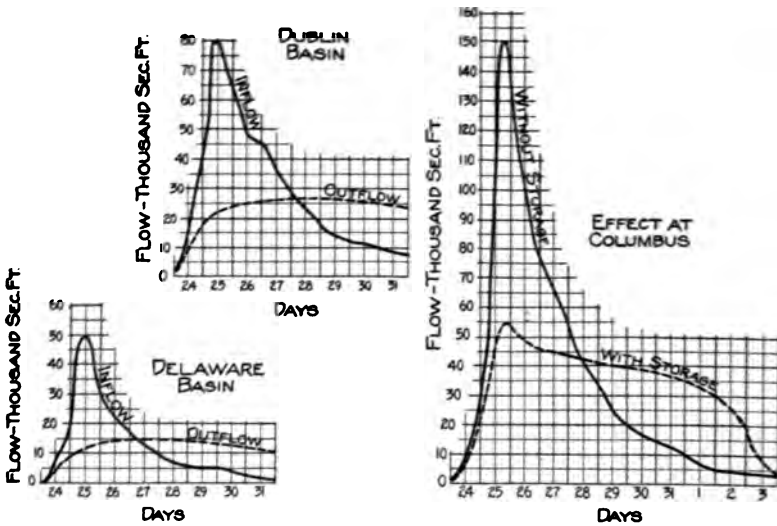

FIG. 41.—Diagram showing flow hydrographs for 150,000 sec. ft. flood with and without detention basins.

2 inches of storage for instance on some of the Western rivers would store the total flow of several years. The data serves to exemplify the general effect of storage in the well-watered country of the Ohio watershed.

In many cases it is advisable to reduce the apex flood rate much more than 50 per cent., and in such cases the capacity for storage must be much greater than for comparatively small flood reductions. This arises from the fact that the extremely high flood rates are of short duration, whereas the more moderate rates of flow persist for a much longer time. Although the flood may have risen to its

x very rapidly, it usually recedes much more slowly.

This is exemplified by the usual characteristics of the flood hydrograph which has a sharp point and widens rapidly as its base is approached.

At the proposed Dublin storage dam upon the Upper Scioto River, it was estimated that 4.82 inches in storage would have been required to have reduced the 1913 flood 60 per cent., by automatic or detention basin storage; 7.96 inches would have been required upon the Olentangy River to have reduced the same flood by the same amount. In the plans of the Miami Conservancy District, storage capacities are proposed at their five reservoirs varying from 4.42 inches to 8.9 inches. All these reservoirs were necessarily quite capacious because it was desired to protect cities some considerable distance below them, and it was, therefore, necessary to reduce the floods to very small rates near the dams so that the river channels could accommodate the flood inflow originating below the dams, but above the places to be protected.

Location of Flood Reservoirs.—A reservoir for the storage of flood waters must be so voluminous that it is practicable to construct it only by building a dam across a river valley particularly in such an advantageous location that with a minimum expenditure for the dam, a large area can be flooded as deeply as possible. Small reservoirs for water conservation have been built outside of the river valley proper, oftentimes in a depression formed by a small tributary, and filled by pumping. Upon the scale that would be required to furnish flood relief, this plan would not be practicable.

A storage dam constructed in the thread of the main stream ordinarily is provided with gates of sufficient capacity to waste the water at such rates as may be desired. The proper protection of the dam usually requires that one or more spillways shall be constructed of such capacity as to prevent the dam from being overtopped if constructed of earth, or to prevent the overflow from reaching a dangerous depth if the dam is built of masonry. The use of gates necessitates the human element with its chance to err in the

TABLE XIX.—LARGE HIGH-HEAD NEEDLE AND GATE VALVES

Type	Location	Number installed	Size	Static head, feet	Maximum capacity, pounds	Weight, pounds	Year installed	Method of operation	Reference
Ball-and-socket (Ensign)	Arrowrock Dam	20	58"	200	1915	Hydraulic and hand	Eng. Rec., 7-11-14
Ball-and-socket (Ensign)	Shoshone Dam	2	58"	1915	Hydraulic and hand	Joshua Hendy Iron Works
Ball-and-socket (Ensign)	Roosevelt Dam	2	1912	Hydraulic and hand	Eng. Rec., 8-8-14
Ball-and-socket (Teichman)	Elephant Butte Dam	60"	1916	Hydraulic and hand
Needle-regulating	Minatare Dam	39"	1914	Hand	U.S.R.S. Specifications
Needle (Johnson)	Phoenix, Utah	12'	140	1915	Hydraulic	Eng. News, 9-9-15
Needle (Johnson)	Ontario Power Co.	8'	1914	Hydraulic	Eng. News, 12-3-14
Needle	Catskill	48'	100	31,000	1912	Motor-worm-screw	Eng. News, 12-1-12
Sluice gates	Roosevelt Dam	10' X 5') operating 7' X 3 7/8")	240	15,000	1907	Hydraulic	Eng. News, 5-30-07
Sluice gates	Shoshone Dam	233	10,000	1908	Oil pressure	Eng. News, 1-3-08
Sluice gates	Pathfinder Dam	7' X 3 7/8") 5.2' X 5.2'	194	2,300 c.f.s.	10,000	1908	Oil pressure	Eng. News, 8-15-12
Sluice gates	Isola, Italy	1	164	23,000	1911	Hand winch	Eng. Rec., 5-20-11
Sluice gates	Chicago Water-works	1	6' diameter	100	150 c.f.s.	1911	Hand	Eng. News, 8-17-11
Sluice gates	Assuan Dam	22.9' X 6.5'	85	1902	Hand	Eng. News, 9-30-09
Sluice gates	Panama Canal Locks	118	*18'10" X 11'1"	72	5,040 c.f.s.	20,000	1914	Electric	Panama Canal Commission
Sluice gates (Coffin)	Vancouver, B. C.	9' diameter	85
Sluice gates (Stoney)	Vancouver, B. C.	10' X 4 9/8"	85
Sluice gates	Bhatgar, India	4' X 8'	60	1912	Eng. Rec., 9-21-12
Sluice gates	McCalla Ferry, Pa.	16 1/2" X 6 1/11"	55	4,000	1890 or earlier	Hand	Eng. News, 4-27-93
Sluice gates	Elephant Butte Dam	4	3 1/11" X 7 6/8"	95,000	1910	Hydraulic	Eng. Rec., 3-4-12
Sluice gates	Elephant Butte Dam	10	4 7/8" X 6 0/8"	1914	Hydraulic	U.S.R.S.
Sluice gates	Catskill	5' X 15'	35	20,000	1912	Electric	Eng. Rec., 9-9-11
Sluice gates	Lehontan Dam	14	36' X 96'	100 to 48
Cylindrical gate valves	Magalloway River, Me.	6' diameter	55	2,000	1912	Electric	Eng. Rec., 3-2-12
Cylindrical gate valves	Panama Canal Locks	6 6/8" diameter	60	1914	Panama Canal Com.	Panama Canal Com.
Cylindrical gate valves	Lehontan Dam	2	102" diameter	102	1913	Hydraulic	U.S.R.S.
Gate valves	Shoshone Dam	30"	227	1908	Hand	Eng. News, 4-2-14
Gate valves (Ludlow)	Chicago Water-works	6'	75	Ludlow Valve Mfg. Co. (Keeler)
Flap gate and disc	Norway and Switzerland	Eng. Rec., 7-26-13

* Opening 150 square feet.

operation of the works, and while gate operation is perfectly satisfactory for water supply, water storage for irrigation and some other purposes, it is desirable for many reasons that the human element shall be eliminated to as large a degree as possible in Works for flood relief.

Large Gates.—The control of large quantities of water under high heads is one of unusual difficulty. This refers

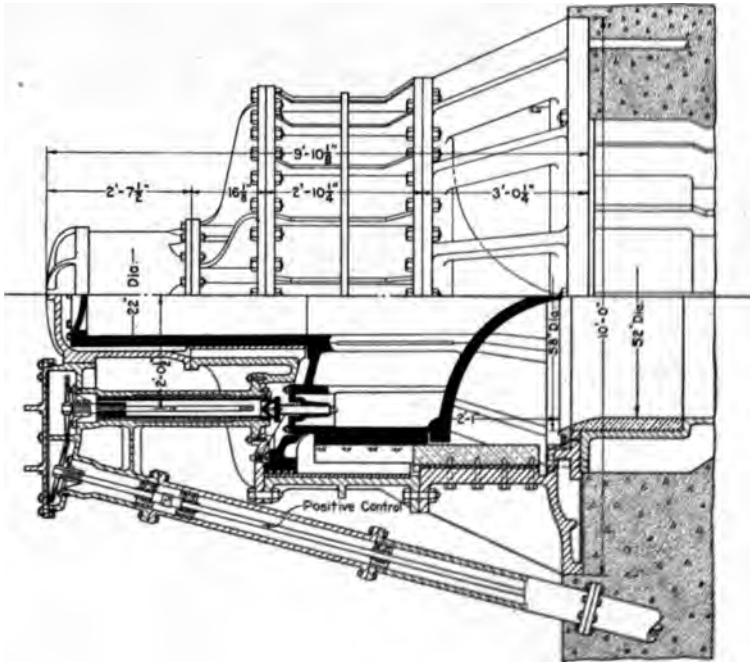

FIG. 42.—58-inch balanced valve with positive control for reservoir outlet from plans by U. S. Reclamation Service.

to heads varying from 100 to 300 feet. The design of small high-head valves has been standardized in water-works practice in which a diameter of about 6 feet is the largest valve required. Much larger gates are used in water-power practice, but usually under moderate heads. The water-power installations have required a few large-diameter high-head valves which have been worked out on the balanced needle-gate principle. The Stoney gates furnishing the main supply for the Panama Canal locks are probably the

largest high-head sluice gates so far built. These gates are electrically operated and bear upon rollers.

In the most recent practice of the U. S. Reclamation Service, the balanced needle gate has been applied successfully in sizes up to 5 feet in diameter under heads up to 200 feet. These gates control the water upon the principle exemplified in the nozzle of the ordinary garden hose, but the needle or plug slides in a receptacle in which the pressures are so controlled that by the operation of the proper pilot valves, the pressure of water in the reservoir will open or close the gate. The gates can be so designed that they are operated by pressure from an external source if desirable. In the design of these gates, and the channels leading therefrom, it is necessary to give particular regard to the acceleration of velocity in order to avoid the formation of a vacuum surrounding the jet. In the operation of the first gates of this type, the vibration and roar made it necessary to cut special openings to relieve the vacuum.

Table XIX shows the principal dimensions of some large high-head gate installations.

Detention Basins.—If one should bore a small hole near the bottom of a 3-gallon bucket, it would be found practicable to maintain a nearly constant stream, although replenishing the bucket intermittently, say a gallon or more at a time. This principle is utilized in works for flood relief by the construction of a relatively high dam containing one or more openings near its base, always open and of such capacity that the reservoir is just filled with reasonable margin for contingencies, during a great flood. Thus, although the flood would be considerably prolonged, its apex rate would be greatly reduced. While openings near the base of the dam are best adapted to most situations, a similar effect is produced by a relatively narrow vertical slot extending the full height of the dam. One of the very early detention dams in France was built upon this principle.

Having surveyed the land subject to flowage so that areas and depths become known, and having investigated the topography of the stream and its flood history so that the

greatest probable future floods can be estimated, it then becomes a question of mathematics as to the height of dam, volume of water impounded, and the capacity of the openings that will be required to control the greatest probable flood. The flood through the openings will gradually increase as the water is impounded behind the dam, the outflow varying approximately as the square root of the head. The maximum delivery will be attained with a full reservoir, and the difference between the unregulated flood apex and this rate of outflow marks the reduction in flood flow effected.

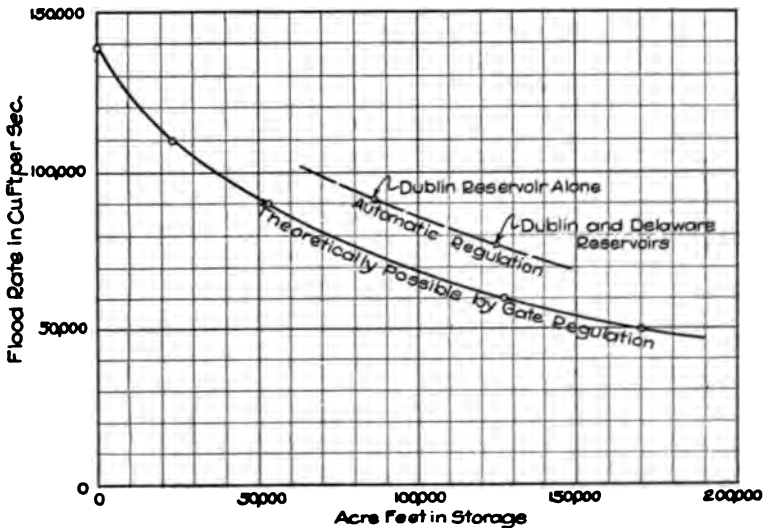

FIG. 43.—Diagram showing the effect of various storage volumes in the reduction of flood rates, Columbus flood of March, 1913.

Automatic Operations.—This type of flood relief has the important advantage that there are no valves to be operated or to fail of operation in an emergency, and no discretion is required as to whether the valves should be opened or closed at any particular time. It must suffer the disadvantage, however, that some of the basin capacity is necessarily occupied long before the flood reaches its apex, and therefore a larger total volume in storage must be provided than would be required if all of the storage could

be utilized on the peak of the flood. While theoretically it would be possible to build hand-regulated gates so capacious that the storage of water could begin at any time, yet except in very small projects, the gates would be so numerous and so large as to be expensive and difficult of operation. It is necessary, therefore, that an excess capacity shall be provided above that theoretically required to allow for the inevitable storage early in the flood. Fig. 43 is a diagram illustrating the excess capacity found to be necessary in the application of a detention dam to the hydrograph of the Upper Scioto River. In this case the detention-basin scheme required from 50 to 75 per cent. more storage capacity than would have been possible theoretically by gate regulation. This relation will vary depending upon the cross-section of the reservoir. Thus, the sacrifice by automatic regulation is less with a reservoir having a "V"-shaped cross-section as compared to a "U"-shaped section, for the larger part of the storage volume in the "V"-shaped section is in the top where it would not be occupied by the minor floods.

To some extent, though to a much less degree, gate regulation suffers the same sacrifice of capacity, for some head would be required to drive even a moderate flood through the gate system even though it should be quite capacious, and this necessitates that some of the reservoir capacity shall be occupied before it can be used to best advantage.

Detention Basins and Land. In the detention basin an important item of cost is land. In the proposed Scioto Valley works, with land at about \$116 per acre, the total land required amounted to \$2,434,000, out of a total estimated expenditure for basins of \$8,211,000, or about 30 per cent. However, unlike the case of ordinary reservoirs, this land would be flooded only rarely, except upon the very lowest ground.

Table XX illustrates the frequency with which various parts of the land would be flooded in three detention reservoirs that were considered for the flood relief of Co-

FLOOD PREVENTION BY WATER STORAGE 143

TABLE XX.—SUMMARIZED FACTORS AFFECTING LAND VALUES
Proposed Detention Basins—Columbus, O., Flood Protection

	Dublin basin	Flint basin	Delaware basin
Total acres of <i>Land</i> below spillway level.....	8,977	4,178	10,918
<i>Zone I.</i> Elevation.....	882 to 900	850 to 860	941 to 951
This land would never be flooded according to experience of past 100 years.			
Acres.....	4,532	792	5,177
Lowest land feet below crest of dam	18	10	9
<i>Zone II.</i> Elevation.....	844 to 882	810 to 850	912 to 941
This land would not be flooded in crop season.			
Acres.....	3,480	2,099	4,894
Out of crop season the lowest of it would be flooded about once in	20 yrs.	6 yrs.	20 yrs.
Depth of flooding on lowest land...	42 ft.	40 ft.	29 ft.
<i>Zone III.</i>			
Frequently flooded land. Lowest every year. Highest once in 6 to 20 yrs. Nearly all could be pastured. Highest ground could be cropped—acres.....	965	1,287	847

lumbus, Ohio, and the Scioto Valley. The estimates in the table are based upon the experience in stream flow upon the river covering the past 18 years. It was proposed to design these basins so that they would just be filled to the crests of their free spillways under a flood 35 per cent. in excess of the great flood of 1913.

In this project the land naturally fell into three zones. Zone 1, comprising 40 per cent. of the total, would fall within the limit of the safety factor, and based upon past experience would never be flooded, although it would probably have to be purchased. Zone 2, comprising an additional 40 per cent. would never be flooded in the crop season, and the highest of this land would not be flooded oftener than once in 100 years based on the known experience of the past. The lowest zone would comprise 20 per cent. of the total, and the lowest land would be flooded

once a year or oftener, and the highest of it would be flooded about once in every 6 to 20 years in the different basins.

Under these circumstances, probably 90 per cent. of the land could be cropped as usual, with a small flood loss upon the low land, and a greater or less return from pasture down to the natural banks of the stream. It will be remembered that it is exceptional for a stream to rise outside of its banks in the growing season of the year, and a bankful stage would be carried through the probable outlet conduits with a small loss of head.

The opportunity is presented for much ingenuity in the acquirement of the necessary land. If the assumptions as to the flooding forecast are correct, the upper zone, comprising 40 per cent. of the total, would not be damaged by flood waters. Practically it would be damaged, however, by the construction of the dam which could create sufficient head to flood it and therefore it would probably be necessary to purchase all of the land up to the crest of the dam. Under the Ohio Conservancy Law, which provides for a continuing board of trustees, it would be possible to operate these lands under a great farming system, after removing the buildings from the lowest grounds. Another plan would be to re-lease the lands after purchase, or perhaps to re-sell the upper zone after the confidence of the community has been restored. There are a number of plans by which the land problem could be handled so as to be at least self-supporting, and allowing for some mismanagement which often accompanies public undertakings, the future possibilities of intensive agriculture are sufficiently attractive to make it reasonably certain that the land under the detention basin plan should finance its own present value.

The detention basin thus presents the anomaly of using the land for two purposes, agriculture and flood relief. This is possible, because the great flood against which we must protect is something of extremely rare occurrence. The average interval between the great floods may be 50 or 100 years, or even more. Under these circumstances,

agricultural land should finance its own investment. If this is not possible, then the price is excessive, unless the land should have a value for purposes other than agriculture that would be destroyed by the construction of the basin. Thus, where the topography is suitable, economical construction will not necessarily require cheap or waste land. This fact much enlarges the practicability and usefulness of the detention basin as a means for flood relief.

Spillways.—There is always danger in the overtopping of a dam unless provision has been made to prevent damage. An earthen dam will be quickly destroyed after the water begins to pass over the top. While low masonry dams can easily be provided to withstand a heavy overflow, there is a limit to the height where considerable depths of water can pass safely over the dam. The safety of the structure will be much improved providing that in emergencies the water may pass around the end of the dam, and those dam sites are particularly advantageous where the topography will permit this with a minimum of construction cost. In a moderately rough country, dam sites are often available, which, by the construction of a dam practically filling the valley, the emergency spillway can lead across the divide and find its way out through the lower end of a tributary to the main stream.

In the design of a detention basin to produce the maximum of effect, the outlets will so be designed that the great flood will not quite fill the basin or possibly a considerably greater flood as a margin of safety may be accommodated before the spillway begins to act; but even so, particularly if an earthen dam is used, it will be prudent to provide a very ample spillway in addition, to act as a safety valve, and thereby to prevent any possibility that the dam could be overtopped and destroyed. This margin of safety often can be made anything desired at small increase in cost by utilizing the emergency spillway as a borrow pit for obtaining the earth of which the main dam is built.

Outlets.—Assuming that the problems relating to flood

hydraulics have been correctly solved, there is no part of a detention dam that requires greater consideration than the design of the outlets. This is particularly true where the conduits are large and operate under a high head. Velocities here must be dealt with comparable to the stream of a fire hose accompanied by a mass, which exceeds any water action in nature, except that occurring at the foot of high water falls.

Valuable experience along this line has been gained in the operation of several of the high dams recently constructed by the Reclamation Service. It has been demonstrated that good concrete masonry may be subjected to velocities resulting from heads as great as 200 to 300 feet, providing that the pathway is straight and free from obstructions tending to cause eddies. Even a slight obstruction may be the cause of rapid erosion. On the Pathfinder dam concrete conduits have successfully accommodated velocities up to 44 feet per second, without erosion, in the absence of obstructions. Upon the other hand, a steel-lined conduit was badly damaged by erosion where the stream was broken up below a set of gates. On the Garun spillway at Panama concrete modules cast-iron faced, that were placed near the foot of the wasteway to break the force of the current, were badly eroded in one year.

A correct design of the detention-basin outlet conduits should be such, far as possible, a gradually accelerating and unobstructed run, and therefore as straight and unobstructed a passage as is possible.

The outlet conduits should be utilized as a foundation for the outlet structure, and for all circumstances the outlet structure should be so designed that the passage of water through it will be unobstructed. The conduits must be designed to give a free exit to the water, and to liberal velocities, and to be so constructed as to be able to resist the high velocities and pressures which may be met in the outlet structure. This is especially true where the outlet structure is a **runnel**, and where the outlet structure is a **runnel** to distribute the water between

earth and masonry. The liberal use of collars or cutoff walls will prove desirable.

There is an opportunity for much ingenuity in the means by which the high velocities in the outlet conduits, which may reach 50 or 60 feet per second, are checked and reduced to the normal velocities of the stream below the de-

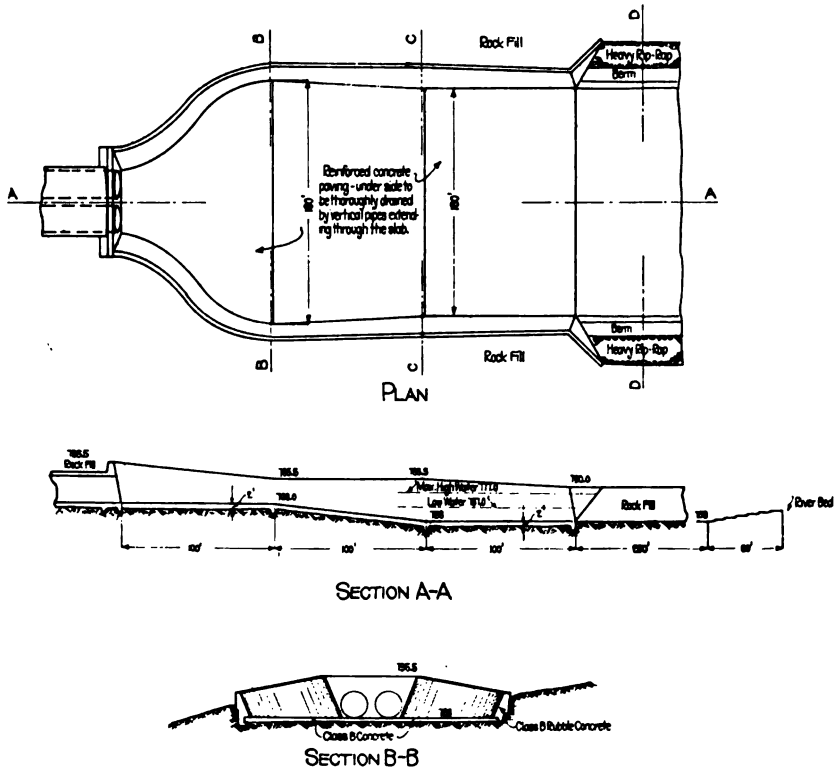

FIG. 44.—Stilling basin below the outlet of the proposed Dublin dam, for reducing the high conduit velocities to velocities that will not erode the natural river channel.

tention basin. This force must expend itself by some means that will not injure the dam.

This problem has been studied experimentally by the engineers for the Miami Conservancy District under the direction of Mr. Arthur E. Morgan, Chief Engineer. Their research seems to indicate that the most practicable outlet consists first, of an expanding section which permits a

high velocity stream of circular cross-section to expand laterally as rapidly as the forward velocity will permit, and after it has attained a considerable width and a shallow depth, with, however, a small decrease in velocity, to precipitate the rapid and wide but shallow stream down a concrete lined declivity into deep water in such a way that a standing wave will be formed well within the area protected by a smooth concrete lining. Shortly below the standing wave the stream will have attained its normal cross section and velocity.

Numerous experiments were tried, looking toward the creation of a standing wave by artificial obstruction other than the drop above mentioned, but the preliminary experiments failed to disclose any means better than the simple arrangement as above described, and as exemplified in the official plans as published by the Miami Conservancy District. No doubt much further study will be given to this problem before the Miami outlets are built.

Ice and Débris. One of the lasting impressions created in viewing a great flood is the amount of floating débris and the rapidity of its travel in the thread of the stream. The difficulties in the maintenance of flood openings from this cause in the detention dam readily suggest themselves, and this is a problem that should receive careful thought in any problem for flood relief by water storage. Those familiar with rivers have noticed, however, that the ice and débris problem is much less acute in lake-fed streams. Thus, on certain lake-fed streams, hard ice is not broken up to pass away on a rapidly flowing flood, but is softened and melted without any special treatment.

A large volume of water, entering a detention flood into a lake, passes through the outlet, more or less, except when the water is so high that it overflows the outlet. In a lake, the water is not so rapidly moving as in a stream, and the ice and débris are not so rapidly moving as in a stream. The water in a lake is not so rapidly moving as in a stream, and the ice and débris are not so rapidly moving as in a stream. The water in a lake is not so rapidly moving as in a stream, and the ice and débris are not so rapidly moving as in a stream.

can be directed to localities where it will strand upon the recession of the flood and can be destroyed by burning when it has become sufficiently dry.

Under certain circumstances it will be desirable to construct drift barriers near the head of the detention-basin pond or at the outlets of the principal tributaries thereto.

At the detention dam some special protection may be required. Where it is possible, it is a good plan to give the outlet conduits sufficient slope so that moderate floods

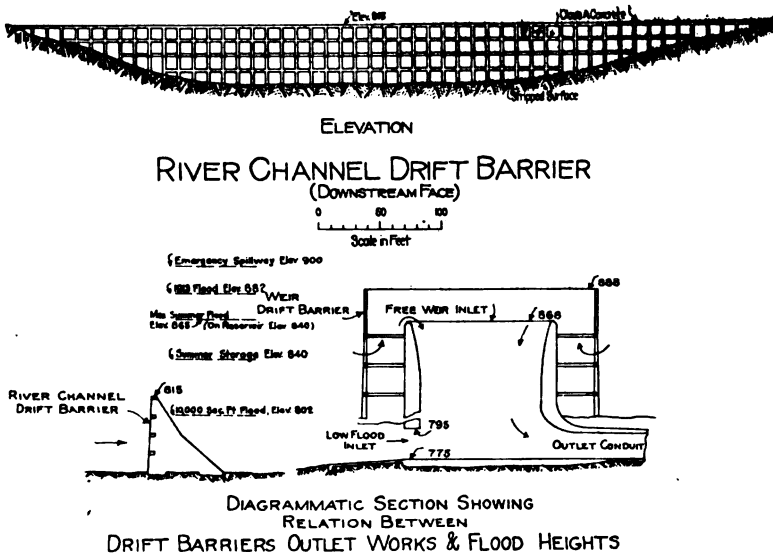

FIG. 45.—Proposed drift barriers for the Dublin dam, to protect the outlets against drift that might cause clogging.

can pass through without completely filling them, thus allowing small drift to pass along. This will accommodate the larger part of the drift coming downstream at ordinary and small flood stages. It may be desirable to construct drift barriers with meshes slightly smaller than the outlet openings in the dam so that floating materials which might clog the openings would be arrested. Such barriers can be placed where moderate velocities prevail. In the proposed works for Columbus and vicinity, the outlet conduits were

thus protected by barriers until the water reached a height which would "drown" the outlet conduits and prevent drift from being sucked in. In the works for Dayton and the Miami Valley floating booms are proposed similar to those utilized in the logging industry.

Water Conservation.—In attempting to use flood storage reservoirs for other incidental purposes, the fact must prominently be kept in mind that a flood reservoir must always lie empty during the season when a great flood may be expected, and in water conservation, a reservoir must be filled prior to a season of drouth and kept as nearly full as possible until the drouth season is past.

In large water-storage projects where practically all the water is caught and stored, these two uses can be accomplished to a greater or less extent, but if water must be in storage during the season of great flood, then there must be charged against the reservoir a certain amount of capacity for flood storage, and a certain amount for water storage. There are situations where these two purposes can be accomplished in one reservoir at less cost than would be possible in separate reservoirs, for usually where topography will permit, the cheapest storage is effected by the upper part of the dam, for the pond usually widens and lengthens with added height.

Occasionally a situation will be found where the detention basin can be utilized for storing water in the growing season of the year, and safely can be emptied with the approach of winter. This is practicable upon some of our Middle Western rivers used for water supply, in which the annual flow is much greater than the water-supply requirements and where a certain amount of storage in the late summer and fall would always be effective in insuring the continuity of water supply for municipal purposes. The rather meager statistics of American streams often show the maximum flood upon the stream to have occurred in the summer or growing season. Except in cases where the summer rains greatly exceed the rains in the barren season, there must come a time if the record is sufficiently pro-

longed, when the record flood will come outside of the growing season. This is due to the fact that the permeable soils of the growing crops of summer are great absorbers of water. Everyone familiar with runoff has noted the great difference in the resulting flood from equal storms in March and July. If the summer storm is sufficiently prolonged, this ground storage is ultimately exhausted, and a very high runoff rate can occur, but the resulting flood will always be less than the rate of runoff resulting from a similar storm in the absence of the ground storage and the retentive effect of vegetation.

In the works for the flood relief of Columbus, Ohio, stream-flow records of the past 18 years indicated that there would be sufficient water storage in the lower 10 per cent. of the proposed Dublin detention basin to supplement the Columbus water supply, and enable it to meet the probable requirements of the city for the next 40 years without storing any water in the winter and early spring months, during which all the greater floods at Columbus have occurred.

Dayton Detention Basins.—The official plan of the Miami Conservancy District which lately has been approved contemplates the largest and most thoroughly studied detention basins that so far have been built in this or any other country. These basins are illustrated in Figs. 46 and 47, and the capacities and the principal dimensions of the dams are shown upon Table XXI.

These basins are purely of the detention type. They accomplish no other purpose for, in their locality, the cities are supplied from ground water and there is no important reason to impound the stream flow other than relieve the flood menace. It is estimated that these basins supplemented by certain minor channel improvements will safely control a flood equivalent to 10 inches in depth upon the watershed running off in 3 days. This would be a flood about 45 per cent. greater than the flood of 1913.

RELIEF FROM FLOODS

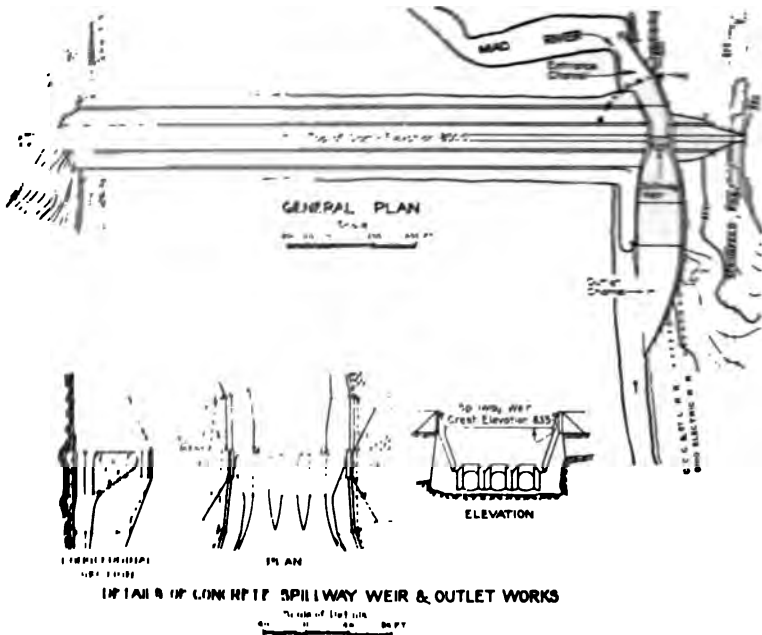
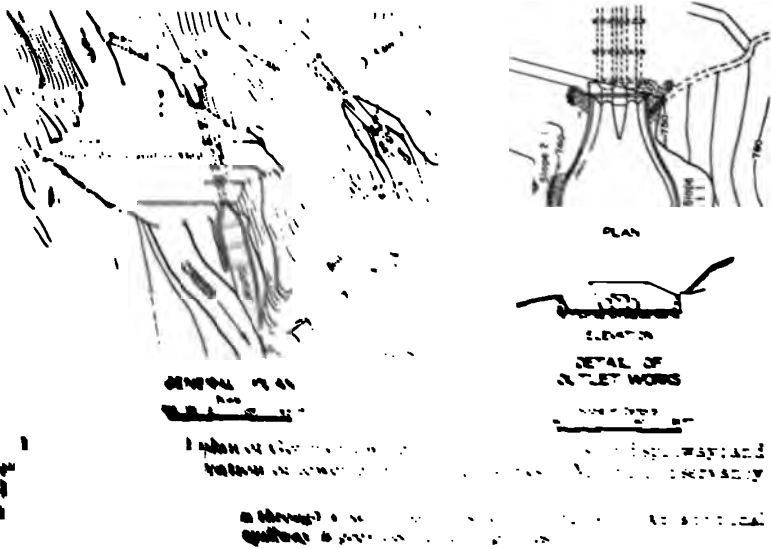

FIG. 10. General plan of Huffman dam, outlet conduits, and spillway; and enlarged plan, elevation, and longitudinal section of combined concrete spillway weir and outlet work. Miami Conservancy District.



FLOOD PREVENTION BY WATER STORAGE 153

TABLE XXI.—DATA REGARDING DETENTION BASINS TENTATIVELY
ADOPTED BY THE MIAMI CONSERVANCY DISTRICT

Reservoir	Stream	Drainage Area above dam site, sq. miles	*Height of dam, stream bed to top	Contents of basin to elevation of spillway		Capacity of tunnels, second feet	Capacity of spillway second feet
				Acre feet	Inches on watershed		
Germantown**	Twin Creek	270	107	106,000	7.30	10,000	32,000
Englewood**	Stillwater	651	124	310,000	8.90	12,000	70,000
Lockington**	Miami	225	78	80,000	6.68	6,200	18,400
Taylorville*	Miami	1,136	78	220,000	4.42	55,000	45,000
Huffman*	Mad	671	73	160,000	4.66	35,000	27,200

*Freeboard of all dams 15 ft. above spillway.

**Reservoirs designed to hold 10 in. of inflow in three days aided by runoff of tunnels.

*Reservoirs designed to hold 9½ in. of inflow in three days aided by runoff of tunnels.

Proposed Works for Scioto Valley.—The following description of the flood-prevention works recommended for the relief of Columbus, Ohio, and the Scioto Valley, will serve to illustrate the general principles that have been outlined above. These works accomplish several purposes, namely, flood relief for a length of river valley approximating 100 miles, including the cities of Columbus, Delaware and Chillicothe. The works further were designed to relieve the bottom farm lands from floods during the crop season only, and the lower portion of the Dublin dam was planned to impound water for the Columbus municipal water supply. Although these plans have not yet received the approval of the Court, and therefore any relief works are in abeyance, a description will serve a useful purpose in illustrating the way in which general principles may be applied to a specific set of conditions.

The Scioto and Olentangy Rivers rise in north-central Ohio, follow a parallel course southward and join at Columbus about 100 miles above the mouth of the Scioto where it joins the Ohio. The watershed above Columbus is 1,614 square miles, with 3,547 square miles above Chillicothe, the lower end of the protected district. The drainage area is rolling with a rather impervious soil. Floods of 30 to 40 second-feet per square mile have been quite common. In 1875 a flood of 45 second-feet per square mile occurred at Columbus. The great flood of

1913 reached a maximum estimated flow of 138,000 second-feet at Columbus, or about 92 second-feet per square mile.

The relief plans outlined propose to control a flood 45 per cent. greater than the flood of 1913, or about 200,000 second-feet at Columbus. By the use of detention basins upon the Upper Scioto and Olentangy Rivers, it was proposed to reduce this provisional flood to about 65,000 second-feet at Columbus.

Relief Works.—The plans proposed to construct detention dams, practically closing the river valleys on the Scioto just above Dublin, and upon the Olentangy above Delaware. Outlet conduits were provided at the bottoms of these dams so proportioned as to limit the rate of water which would be delivered below the dams. The surplus above this predetermined rate would be impounded in the detention reservoirs and re-delivered to the stream after the flood apex. The outlet works and the basins were so proportioned that the basins would not be filled under a repetition of the 1913 flood, and would barely be filled by a provisional flood exceeding the 1913 flood by 45 per cent.

The plans embody earthen dams of very liberal cross-sections 143 feet high at Dublin, and 82 feet high at Delaware.

Operation of Dublin Basin.—The operation of the Dublin basin will require the services of an attendant who will live at the dam, and whose duty it will be to operate the gates in accordance with regulations laid down by the Conservancy Board of Directors. In a great flood the operation of these gates is not important, that is, the works are so designed that the capacity of the outlet works is not materially affected whether the gates are closed or opened. They are of use only to control the Columbus water supply, and to a certain extent in the protection of the farm lands.

Assuming all the works to be completed, we will start about the middle of April in the normal season, and describe the operations at the dam. By this time in the normal year, or in any event not later than the first of May, **vegetation** will be well started, and all danger from a record

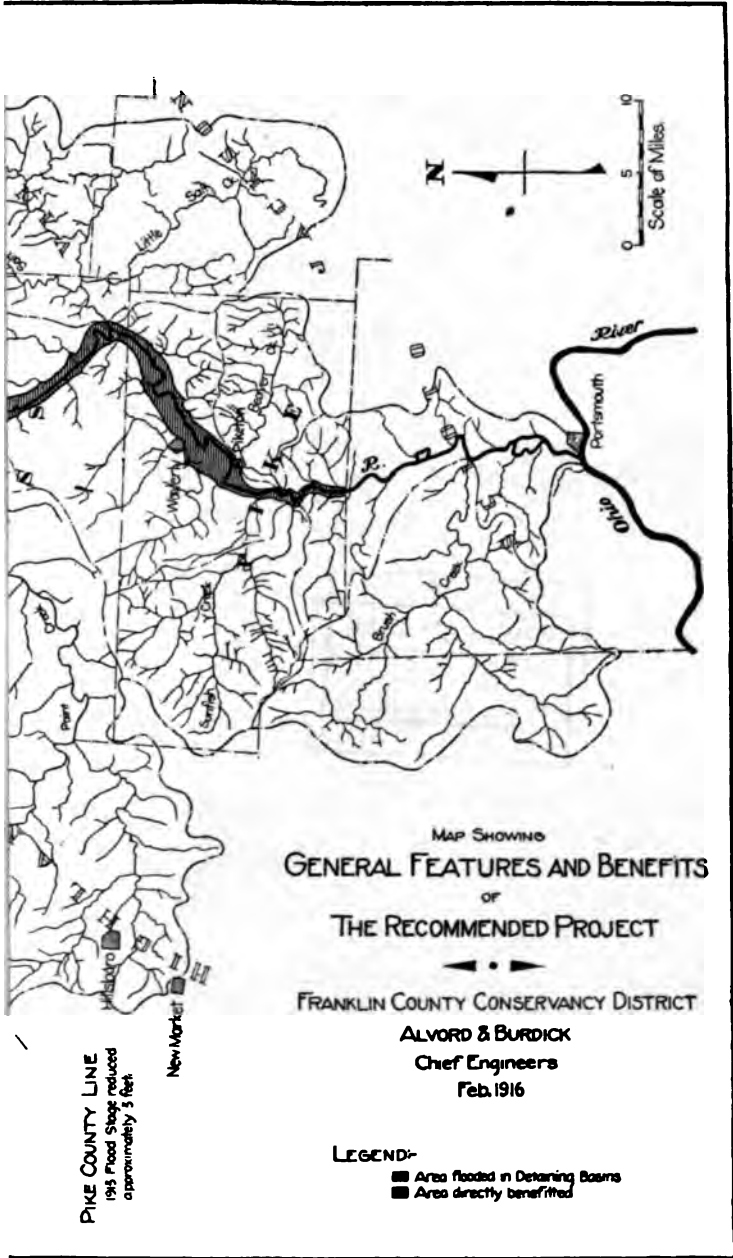

Facing page 164.

FIG. 48.

THE UNIVERSITY OF
MICHIGAN LIBRARY
ANN ARBOR, MICHIGAN
48106-1000

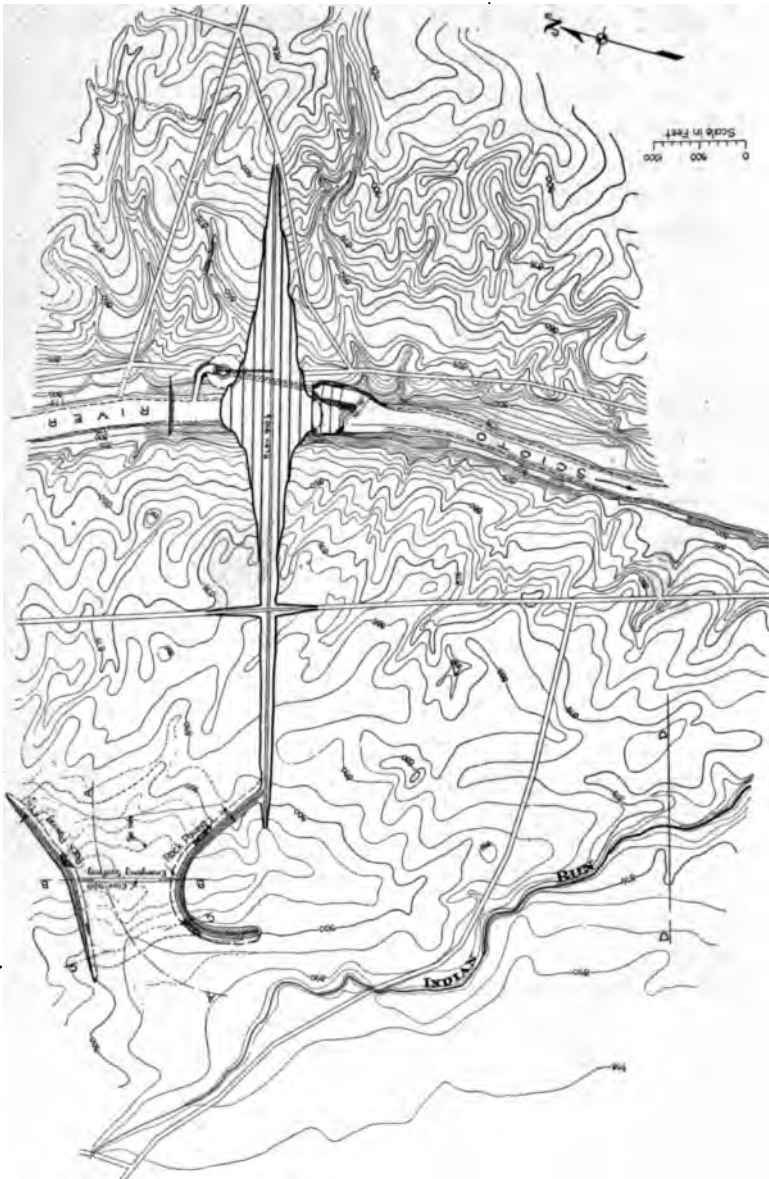

FIG. 49.—Proposed Dublin detention dam practically filling the river valley with an emergency spillway remote from the dam into a small tributary.

flood will have passed. As soon after this time as the river falls to a low stage, all gates will be closed and the water will be allowed to rise behind the dam to such amount as is necessary to store the water required for the City of Columbus in the very driest season. The height to which the water will thus be ponded will vary with the growth of Columbus. The river bed at the dam is at elevation 767. By the year 1920 it will be necessary to pond the water up to elevation 800. In the year 1950, the level will be carried at about elevation 839.

The water having risen to the height required for Columbus water storage, one or more of the balanced needle gates will be opened to such amount as is necessary to hold the pond level, the gates being altered possibly once a day to accommodate the fluctuations of flow coming in.

In the event of a hard summer rainstorm, the needle gates will be gradually opened holding the pond level in accordance with the water coming down, until a flow of about 5,000 second-feet is reached, as evidenced by a gage downstream from the dam. This flow measures approximately the amount of water that it is desirable to deliver to the stream in summer, to obviate the overflow of farm lands. If the water coming into the basin exceeds 5,000 second-feet, the surplus will be allowed to rise, and in the event of a great summer flood such as occurred in 1915, the water will rise up to about the top of the free-concrete spillway of the gate house. The plan places the lip of this spillway at elevation 868. This provides for the probable conditions of 1930 or 1940, depending upon the growth of the city of Columbus, and the amount of water that necessarily must be stored for it. At a later date, the lip of this spillway can be somewhat increased in height.

The valves being set at 5,000 second-feet delivery, after the water has ceased coming into the basin, the surface will rapidly fall, and when it has fallen to the level required for the Columbus storage, the balanced needle gates will be closed in sufficient amount to hold the pond at this elevation.

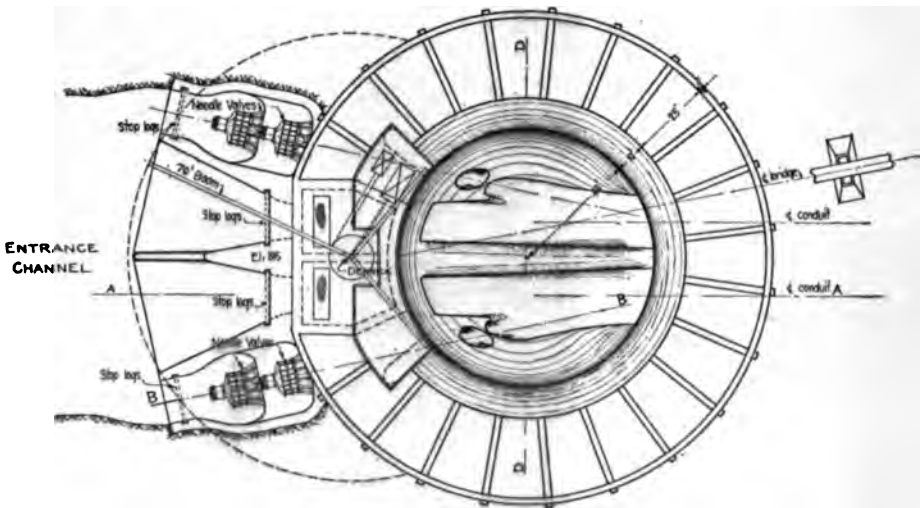
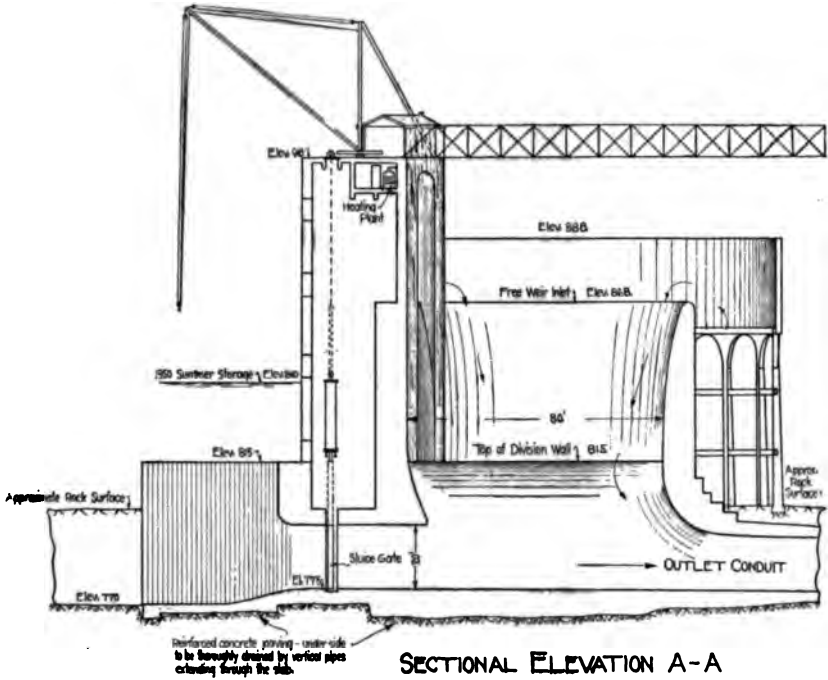
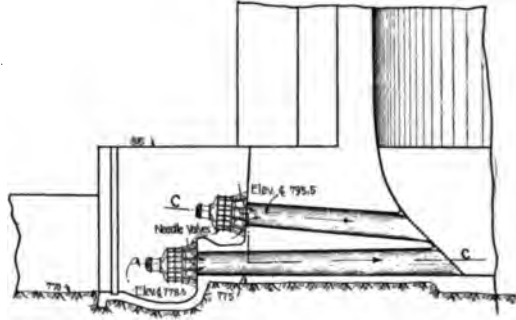

FIG. 50.—Outlet works for the proposed Dublin dam. The gates control the water of the small summer floods and for the Columbus water supply. In great floods, the outlet is automatic.

When the growing season has passed, say, about Nov. 1, in a normal year, after which the water storage is not required for Columbus, and after which a record flood may be anticipated, the needle gates will be opened and the water stored will be allowed to drain away. When the water in



SECTION B-B

0 20 40
Scale in Feet

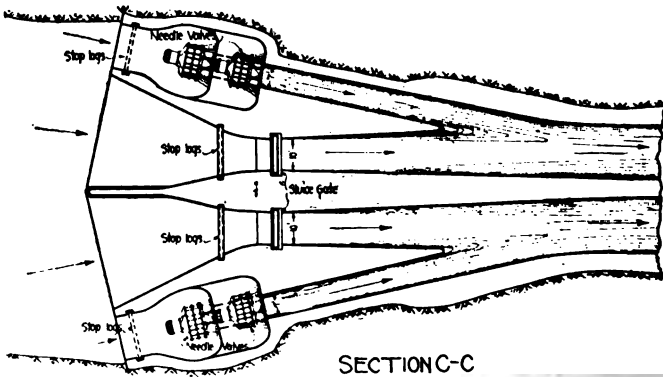

SECTION C-C

Fig. 51. Gates for controlling the small floods and the stored water supply for the proposed Dublin dam.

the basin has fallen to about elevation 815, or 20 feet above the top of the large rising stem gates, these gates may be opened, but this would probably not be done until the water had fallen somewhat lower, say to elevation less. At this point all the gates would

until the next growing season is well advanced, the river would be allowed to pass through the gates freely, except for such obstruction as is furnished by the outlet conduits. The gates are so proportioned as to produce only a minor obstruction to the passage of the water, the flow being principally governed by the outlet conduits for all stages of water when the gates are open, and even if the gates are

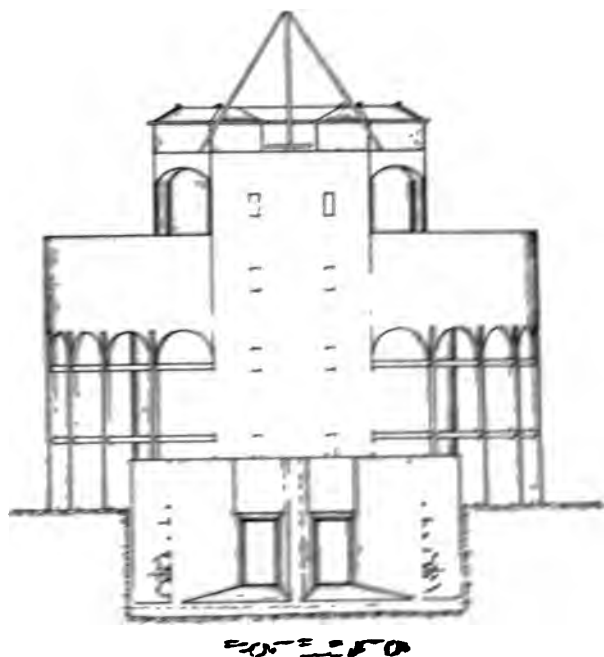

FIG. 32.—Elevation of the water works of proposed Dams section dam

closed, the overflow governs the delivery for stages of water above the top of the concrete-free spillway.

In the event of a record fresh like the fresh of 1913 the water will rise up to about elevation 492 or 20 feet above the emergency roadway, or 20 feet above the top of the dam. With this stage of water in the main the 22,000 cubic feet per

emergency roadway, or 20 feet above the top of the dam. With this stage of water in the main the 22,000 cubic feet per

of about 25 per cent of the water will rise

approximately to elevation 90, which is the crest of the free wasteway. At this stage of water the turbines will be delivering about 31,000 horse-feet per second.

Operation of the Delaware Basin.—As no water is impounded for Columbus and therefore no gates are necessarily installed, the operation of the Delaware detention basin is entirely automatic. In an excessive flood the outlet works at the dam will be entirely submerged. The outlet conduits are in duplicate to provide for repairs at the low-water season. Each conduit is supplied through two openings.

The lower or small opening is for the purpose of regulating the minor floods: particularly to regulate the summer floods for the benefit of the bottom lands. The top of this opening is level with the top of the outlet conduit to facilitate the passage of small drift. The two lower water openings will discharge 5,000 second-feet under a head level with the top of the free weir inlet, which marks the elevation to which the summer flood of 1915 would rise if repeated. This is the greatest summer flood of which we have accurate record. In the case of a great flood such as might occur in the barren season of the year, the capacity of the outlet will greatly increase as the water rises above the lip of the free weir inlet. Thus, at elevation 924, the delivery is entirely governed by the conduit cross-section, the discharge of the two conduits being about 9,500 second-feet.

The 1913 flood would rise approximately to elevation 940, or 10 feet below the emergency wasteway, or 20 feet below the top of the earthen dam.

The provisional flood, 45 per cent. greater than the flood of 1913, would rise to the level of the emergency spillway at elevation 950.

In providing for the control of summer floods, with the inlets arranged as above described, a small part of the basin capacity is sacrificed that would otherwise be available for storage of the very excessive floods. This loss of capacity is small, however, it being estimated that the dif-

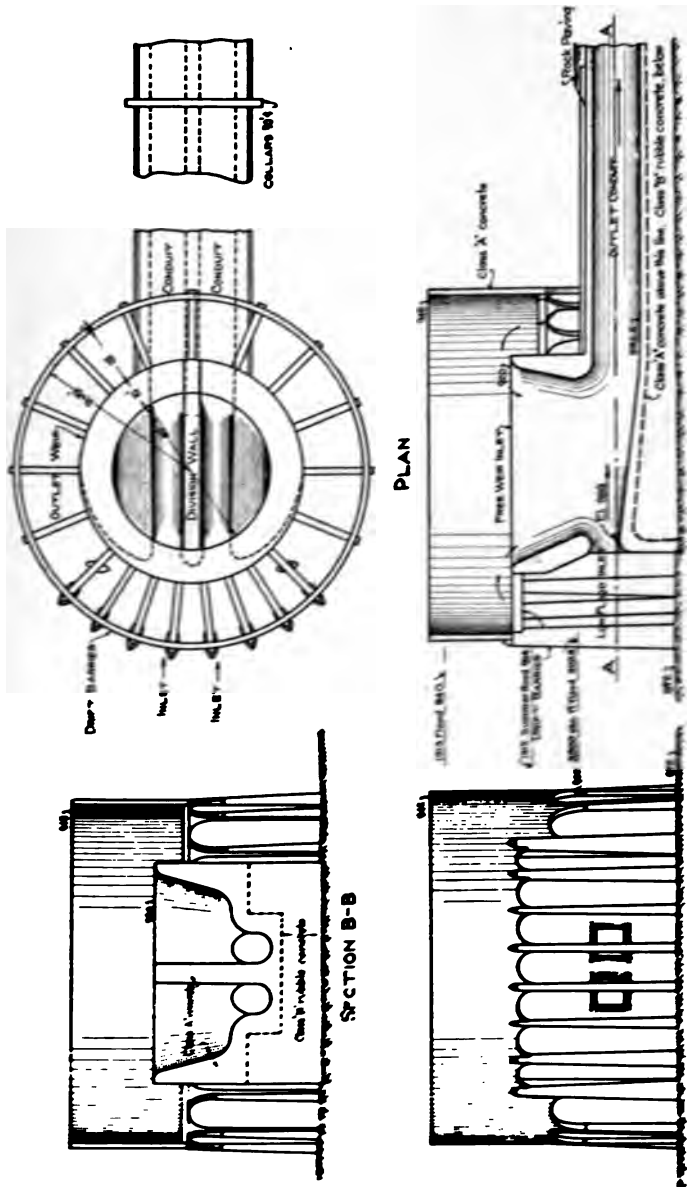

FIG. 31. Outlet works at the proposed Delaware detention dam. The logs supporting the main drift barrier serve to screen the low flood openings at ordinary water stages.

ference in water level within the basin with and without the summer flood-control opening, would be less than 1 foot under a repetition of the 1913 flood.

Basin Effect on River Stages.—The effect of the official plan upon the flood stages varies in different parts of the river, depending upon the distance from the detaining basins and also the special conditions existing at different places. The river channel in Columbus is designed to safely carry 64,000 second-feet. This is based on 24,000 second-feet from the Dublin basin, 11,000 second-feet from the Delaware basin, and 29,000 second-feet from the 230 square miles of area below the basins. This is 124 second-feet per square mile. The flood of 1913 averaged 85 second-feet per square mile for the whole area above Columbus. The 1913 flood reached 22.9 feet on the Mound Street gage, about two-thirds of the water passing through the Columbus West Side. With the channel as improved, this flood would be carried through Columbus at a stage about 3 feet less at Mound Street as compared to the flood of 1913.

At Delaware the 1913 flood reached an elevation equivalent to 26.3 on the present Williams Street gage. It is estimated that the Delaware basin would reduce this flood if repeated, by the amount of about 12 feet. The provisional flood, 45 per cent. greater than the flood of 1913, would probably reach about gage 32. It is estimated that the Delaware basin would reduce this flood height by 17 feet.

The city of Circleville was not materially affected by the flood in 1913 except indirectly, but as a gage is located at this place estimates in reference to Circleville will serve to show the effect of the detention basins upon the adjacent territory. The 1913 flood reached 24.2 feet on the Circleville gage. It is estimated that the basins would reduce this flood height not less than 2 feet. The provisional flood would probably rise about 3 feet higher than the flood of 1913, and the basins would have the effect of reducing it to about the level of the flood of 1913.

Downstream

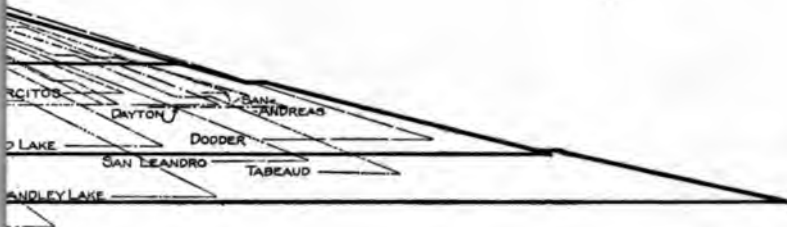

KS

1909.

Downstream Face. 15 berms located 5' to 97' down. Also a 10' berm 75' down.

Upper Slope 2 1/4:1 for upper 69 ft.

Lower slopes with 10' berms every added 30' of height.

Facing page 162.

1. The first part of the document discusses the importance of maintaining accurate records of all transactions and activities. It emphasizes the need for transparency and accountability in financial reporting.

2. The second part of the document outlines the various methods and techniques used to collect and analyze data. It includes a detailed description of the experimental design and the procedures followed during the study.

3. The third part of the document presents the results of the study, including a comparison of the different methods and techniques used. It also discusses the implications of the findings and the potential applications of the research.

At Chillicothe the 1913 flood reached 37.8 feet on the Bridge Street gage. This level was obtained with a large amount of water flowing around the gage and through the city of Chillicothe at the apex of the flood. It is estimated that with the basins of the official plan constructed, the 1913 flood repeated would rise approximately to gage height 31, a reduction of about 7 feet, of which about 1 foot would be attributable to enlargements in the bridge openings in Chillicothe since 1913. The provisional flood 45 per cent. greater than the flood of 1913 would rise to about gage 45 without basins, and the basins are estimated to produce substantially the same reduction as has been above estimated for the flood of 1913.

Intermediate between these places, the effect of the basins will vary between the limits here set down at the salient places. Where the flood channel is wide and deep, the effect of the basins will be least. Where the channel is contracted, the basins will produce their greatest effect. The principal benefit to be secured by these works lies in the protection of the cities and the saving of life.

Local Conditions Must Govern.—The science of flood protection is so young that it is dangerous to attempt to draw conclusions that would be generally applicable. Each case must be a case by itself. Detention basins must be impracticable where no basin sites exist, but it is not wise to assume that sites are not available until computations have been made to determine the dimensions of basins that would be required, and until a reconnaissance has demonstrated that there is no good prospect of locating adequate basin sites. A study of the flood problems that have received careful attention will show that almost any reasonable remedy has its place somewhere. It is only by a good knowledge of the fundamental principles and ingenuity in their application, that our flood problems may be solved with assurance that the works shall be economical and effective.

APPENDIX

TABLE OF GREAT FLOODS IN THE UNITED STATES

The tabulation which follows shows all data available to the authors on the maximum flood flow rates of the rivers of the United States, having records covering 10 years or more. The information has been obtained largely from the *U. S. Water Supply Papers*, but has been supplemented by other data. Although the records of all streams have not been brought down to so late date, all those figures published up to 1916 have been examined and tabulated.

Following the idea suggested by Mr. Weston E. Fuller, C. E.,¹ the endeavor has been made to secure what information is available upon the relation between the great floods and the ordinary or average floods upon these rivers. These ratios are shown in the tabulation.

Quite often figures purporting to be maximum flood flows have been published that resulted from only a short period of observation and therefore might be given undue weight by those not conversant with the facts. In the table which follows, the maximums represent the flow rates in the greatest floods that have occurred within the period of observation, the length of which is shown. The endeavor has been made further, to distinguish between apex flood rates proper, and rates of flow which, although the greatest appearing upon the record, may or may not represent the flow exactly at the apex. Upon the rivers of large drainage area, this makes practically no difference, but the difference may be material on rivers under 1,000 square miles in drainage area. Generally, in a great flood, apex measurements were made, and where the measurement is known to have been made, it is indicated in the table by a suitable

¹ "Flood Flows," *Transactions*, American Society of Civil Engineers, vol. 77.

symbol. Except as otherwise stated, the rates of maximum discharge represent the greatest flow rates that appear in the records, and may or may not represent the apex strictly speaking.

The column referring to average annual floods, has been brought down to date, and differs slightly from the information published by Mr. Fuller in 1913, both by reason of the consideration of a greater number of years and by reason of a number of great floods that have occurred since his data were published.

RELIEF FROM FLOODS

II.—GREATEST FLOODS AND FLOOD RATIOS ON STREAMS OF THE UNITED STATES HAVING RECORDS OF 10 YEARS OR MORE, INCLUDING ALL RECORDS PUBLISHED UP TO THE YEAR 1916
(From records of the United States Geological Survey and other records)

Stream	Place measured	Drainage area, square miles	Years of record	Date	Greatest flood		Average annual flood, second-foot	Ratio of maximum to average flood, Col. 8 ÷ Col. 8
					Second-foot	Maximum discharge, Second-foot per square mile		
(1)	(2)	(3)	(4)	(5)	(6)	(7)	(8)	(9)
NEW ENGLAND STREAMS:								
Connecticut	Hartford, Conn.	10,234	70 (d)	5/54	205,000* (d)	20.00 (d)	112,700 (d)	1.82 (d)
Merimac	Lawrence, Mass.	4,663	36	3/3/96	90,000* (g)	19.30	30,300	2.30
Pemigwasset	Plymouth, N. H.	615	28	7/07	30,640	49.80	16,350	1.87
Cobbeseconite	Gardiner, Me.	220	25	3/12/03	3,275	14.90	1,750	1.87
Kennebec	Waterville, Me.	4,270	22	12/16/01	156,800*	36.70	65,700	2.32
Andromogain	Rumford Falls, Me.	2,090	22	4/15/95	55,230	28.41	23,800	2.32
Connecticut	Holyoke, Mass.	8,390	20	4/16/95	115,000	13.71	72,200	1.59
Connecticut	Orford, N. H.	3,100	16	3/28/13	57,300*	18.40	35,500	1.61
Pennobscot	West Engfield, Me.	6,600	14	9/27/09	95,700*	14.64	62,500	1.54
Kennebec	The Forks, Me.	1,570	14	01	19,890*	12.61	13,600	1.41
Pennobscot (W Br)	Millinocket, Me.	1,880	11	4/03	24,250*	12.90	17,200	1.41
Hudson River Streams:								
Hudson	Mechanicville, N. Y.	4,500	25	3/28/13	120,000*	26.70	47,000	2.55
Hudson	Ft. Edward, N. Y.	2,900	19	3/28/13	89,100*	31.80	37,500	2.37
Mohawk	Dunbar Ferry, N. Y.	3,430	15	10/10/03	84,480	24.75	45,800	1.85
East Canada Cr.	Dolgeville, N. Y.	256	16	3/27/13	13,900*	44.30	6,150	2.26
Roundout Cr.	Rosendale, N. Y.	368	10	4/26/10	19,510	50.80	12,560	1.55
MIDDLE ATLANTIC STREAMS:								
Tobacco Cr.	Point Pleasant, Pa.	102	31	5/21/94	14,100* (g)	138.30	3,750 (g)	3.76
Neshaminy Cr.	The Forks, Pa.	139	30	5/21/94	19,000* (g)	136.75	4,406	4.32
Pasque	Harrisburg, Pa.	823	27 (a)	10/10/03	35,800* (g)	43.60	19,365	2.19
Susquehanna	Duaneburg, Pa.	24,000	54	6/89	700,000* (g)	30.66	298,000	2.35
Potomac	Point of Rocks, Md.	9,650	50	3/02	219,000* (g)	22.70	110,100	1.97
Susquehanna (W Br)	Williamsport, Pa.	5,670	19	3/2/02	164,100	28.93	105,200	1.56
Monocacy	Fredrick, Md.	6,660	19	3/2/02	202,460	30.97	138,990	1.47
Susquehanna	Dyersville, Pa.	11,300	15	3/2/02	304,800	26.97	149,500	2.04
Susquehanna	Wilkes-Barre, Pa.	9,510	15	3/2/02	225,500*	22.94	124,800	1.90
Juniata	Shenandoah, Pa.	3,490	16	3/1/02	292,700	44.00	76,200	3.84
Shenandoah	Millersburg, W. Va.	2,995	15	10/1/96	139,700	86.65	40,800	3.42
Shenandoah	Phillipsburg, Pa.	1,920	14	2/26/02	82,156* (g)	42.77	30,400 (g)	2.70
Perthman Cr.	Fredrick, Pa.	1,152	30	5/21/94	17,900* (g)	115.80	4,890	3.61

Susquehanna.....	Binghamton, N. Y.	2,400	12	3/2/02	60,400*	25.15	30,100	1.55	
Chenango.....	Binghamton, N. Y.	1,530	11	3/2/02	35,950*	23.50	23,950	1.39	
Patapsco.....	Woodstock, Md.	251	11	2/26/08	11,000	42.80	6,850	1.61	
SOUTH ATLANTIC STREAMS:									
Savannah.....	Augusta, Ga.	7,500	56(a)	9/11/78	310,000*(g)	41.30	143,250(a)	2.16	
Alabama.....	Selma, Ala.	15,400	25	1/19/92	146,900*(f)	9.50	18,500	1.23	
Coosa.....	Riverside, Ala.	7,060	20	3/30/06	78,800	10.72	54,350	1.39	
Chattahoochee.....	West Point, Ga.	3,300	20	12/30/01	85,600	20.85	44,500	1.99	
Ocmulgee.....	Macon, Ga.	2,420	10	3/1/02	50,000*	21.00	34,100	1.49	
Oostanaula.....	Reasas, Ga.	1,610	10	9/15/08	39,200*	24.35	22,900	1.71	
James.....	Buchanan, Va.	2,060	18	9/18/08	62,000*	30.10	39,100	1.59	
Black Warrior.....	Cartersville, Va.	6,230	17	12/30/01	160,000*	17.00	99,900	1.77	
Yadkin.....	Tuscaloosa, Ala.	3,400	17	3/18/00	157,000*	32.05	119,700	1.31	
Broad of Georgia.....	Salisbury, N. C.	3,000	17	3/25/08	130,000*(g)	28.30	60,300	2.16	
Flint.....	Cartersville, Ga.	7,62	17	8/25/08	47,200	62.00	20,500	2.30	
Oconee.....	Woodbury, Ga.	1,090	16	3/15/13	35,300*	32.35	16,300	2.16	
Talapoosa.....	Dublin, Ga.	4,180	15	3/20/12	43,900*	10.50	28,300	1.55	
Tombigbee.....	Sturdevant, Ala.	2,460	14	3/20/06	59,100*	24.00	35,400	1.67	
Coosa.....	Columbus, Miss.	4,500	13	3/31/02	50,420	11.35	34,700	1.45	
Coosa.....	Carters, Ga.	531	12	1/19/06	17,700	33.30	12,500	1.42	
Turlough.....	Madison, S. C.	4,610	11(g)	5/1/05	21,860	36.85	14,050	1.55	
Broad of Carolina.....	Clinton, S. C.	904	12(g)	5/22/01	19,000(g)	31.47	76,400(g)	1.72	
Etowah.....	Alston, Ga.	831(g)	10(g)	37,250(g)	44.80	13,440(g)	1.41	
James (N. Fork)(g).....	Greensboro, Va.(g)	1,100	11	8/26/08	25,300	23.00	16,600(g)	2.24	
Oconee.....	Greensboro, Ga.	1,100	11	8/26/08	25,300	23.00	12,520	2.02	
OHIO RIVER BASIN:									
Allegheny(e).....	Kittanning, Pa.(e)	9,010	41	3/26/13	269,000*	29.90	151,300(e)	1.78	
Tennessee.....	Chattanooga, Tenn.	21,400	41	3/11/07	735,000*(f)	34.37	217,000	3.39	
Youghiogheny.....	Belov Confluence, Pa.	782	32(a)	8/21/88	44,000	56.25	26,300(a)	1.67	
Ohio.....	Wheeling, W. Va.	23,800	27	2/7/84	507,000*	21.30	308,200(a)	1.64	
Tennessee.....	Johnsonville, Tenn.	35,900	24	3/24/97	410,000*	10.64	241,000	1.70	
Monongahela.....	Rock No. 4, Pa.	5,430	20	7/11/88	207,000*	38.12	110,000	1.88	
Tennessee.....	Florence, Ala.	30,800	19	3/16/97	499,330*	16.21	240,500	2.07	
Hwassee.....	Murphy, N. C.	410	19	3/19/99	22,360*	54.55	11,400	1.96	
Greenbrier.....	Alderson, W. Va.	1,340	18	3/27/13	60,000*	44.76	35,000	1.71	
French Broad.....	Radford, Va.	987	18	3/15/99	30,500	30.90	17,000	1.79	
New.....	Ashford, Va.	2,720	17	10/00	173,600*(f)	63.78	56,200	3.09	
Little Tennessee.....	Judson, N. C.	675	17	2/28/02	57,540*	85.25	24,700	2.33	
Tuckasee.....	Bryson, N. C.	662	17	3/19/99	38,550*	58.20	22,400	1.72	
Lower Scioto(c).....	Columbus, O.	1,570(c)	16	3/25/13	138,000*(e)	87.90	35,700(c)	3.87(h)	
Upper Scioto(c).....	Columbus, O.	1,032(c)	16	3/25/13	78,000*(e)	75.60	20,350(c)	3.83(h)	
Olentangy(c).....	Columbus, O.	520(c)	16	3/25/13	60,000*(e)	115.30	15,400(c)	3.90	
Tennessee.....	Knoxville, Tenn.	8,990	14	3/1/02	157,410	17.51	90,300	1.74	
Hwassee.....	Reliance, Tenn.	1,180	13	11/19/06	55,200*	46.80	27,000	2.04	
Miami.....	Dayton, O.	2,450(g)	21(g)	3/25/13	246,000*(g)	100.30	50,000(g)	4.92	
ST. LAWRENCE RIVER BASIN:									
Moose.....	Moose River, N. Y.	370	15	3/27/13	15,500*	41.90	6,090	2.54	
Genesee.....	Rochester, N. Y.	2,360	11	3/65	50,000	21.18	24,500	2.04	
Fox.....	Rapide Croche, Wis.	6,200	10	5/29/02	12,317	1.99	9,930	1.24	

TABLE XXII—(Continued)

Stream (1)	Place measured (2)	Drainage area, square miles (3)	Years of record (4)	Date (5)	Greatest flood		Ratio of maximum annual flood, second-foot flood, col. 8 to average flood, col. 8 (9)	
					Maximum discharge	Second-foot per square mile		
					Second-foot (6)	(7)		
UPPER MISSISSIPPI RIVER BASIN:								
Des Moines(c)	Des Moines, Ia.	6,462(c)	20	5/31/'03	49,000*(c)	7.58	18,400(c)	2.66
Chippewa	Chippewa Falls, Wis.	5,600	27	6/7/'05	64,400	11.49	33,500	1.92
Illinois(c)	Peoria, Ill.	13,479(c)	25	3/28/'04	80,000*(c)	2.36	26,200(c)	3.05
Mississippi	St. Paul, Minn.	35,700*	23	4/6/'97	80,800*	2.12	39,500(b)	2.05
Mississippi	Above Sandy R., Minn.	4,510	20	9/20/'00	9,572	2.12	5,160	1.85
Pine River	Below Pine R. Reservoir, Minn.	4,52	19	6/29/'01	1,586	3.51	943	1.68
Cedar	Cedar Rapids, Ia.	6,320	15	4/17	56,000	9.0	29,000	1.93
MISSOURI RIVER BASIN:								
Kansas	Lawrence, Kan.	59,841	25	5/31/'04	233,070*	3.98	42,500	5.48
Kansas	Lecompton, Kan.	58,550						
Loup	Columbus, Neb.	13,500	20(a)	6/6/'96	70,000	5.19	17,700(a)	3.96
Platte	Columbus, Neb.	56,900	19	6/15/'05	51,000*	0.90	23,900	2.13
North Platte	North Platte, Neb.	28,500	19	6/4/'08	25,500	0.89	15,600	1.63
Milk	Havre, Mont.	5,050	14	6/9/'08	9,600	1.90	4,160	2.31
South Platte	Denver, Colo.	3,840	14	1900	5,163	1.770	1,770	2.92
Cache la Poudre	Ft. Collins, Colo.	1,060	12	5/22/'01	5,100	4.81	3,180	1.60
Republican	Junction, Kan.	25,837	11	5/30/'03	59,400*	2.30	20,800	2.88
Blue	Manhattan, Kan.	9,490	11	5/31/'03	86,640*	9.13	27,500	3.15
West Gallatin	Saleville, Mont.	860	10	5/18/'01	7,810	9.08	4,708	1.66
St. Vrain Cr.	Lyons, Colo.	209	10	6/17/'03	1,280	6.12	770	1.66
LOWER MISSISSIPPI RIVER BASIN:								
Arkansas	Pueblo, Colo.	4,600	28	5/21/'01	11,060	2.40	5,130	2.16
Arkansas	Canyon City, Colo.	3,050	26	6/10/'05	6,690	2.19	3,800	1.76
WESTERN GULF OF MEXICO BASIN:								
Rio Grande	Del Norte, Colo.	1,400	24	10/6/'11	14,000	10.00	5,270	2.66
Colorado	Austin, Tex.	37,000	16	4/7/'00	123,000	3.32	46,100	2.67
Brazos	Waco, Tex.	30,800	14	5/25/'08	132,000	4.29	55,100	2.40
GREAT BASIN:								
Bear	Collinston, Utah.	6,000	24	1/7/'09	11,600	1.93	6,520	1.78
Humboldt	Golconda, Nev.	10,800	18	5/1/'07	3,160	0.29	1,335	2.37
Humboldt	Oreans, Nev.	13,800	16	5/4/'07	2,220	0.16	851	2.61
Bear	Preston, Idaho.	4,500	16	3/15/'10	6,380	1.42	4,060	1.57
Humboldt (S. Fork)	Elko, Nev.	1,150	16	6/23/'99	2,339	2.03	1,216	1.92

APPENDIX

Provo.....	640	16	6/7/09	2,400	3.75	1,742	1.38
Truckee.....	519	16	7/13/07	1,340	2.58	765	1.75
Logan.....	218	16	6/8/07	2,450	11.24	1,444	1.70
Parley's Cr.....	50	16	6/7/09	274	5.47	132	2.08
Big Cottonwood Cr.....	48.5	16	6/6/09	835	17.20	469	1.78
Mill Cr.....	19.2	16	5/31/12	121	6.88	74	2.09
City Cr.....	21.3	15	5/07	132	5.68	58	1.78
Truckee.....	955	13	3/18/07	15,300	16.02	4,970	3.08
Carson (W. Fork).....	70	12	5/17/07	1,570*(f)	22.43(f)	879	1.79
Colorado.....	225,000	12	6/25/09	150,500*	0.67	89,800	1.68
Carson (E. Fork).....	381	10(a)	6/4/09	3,430(a)	9.02	2,427(a)	1.41
SOUTHERN PACIFIC COAST:							
Kern.....	2,345	20	6/21/06	9,505	4.06	4,071	2.33
Red Bluff, Cal.....	10,400	19	2/3/09	278,000*	26.70	114,500	2.43
Kings.....	1,740	18	1/7/01	43,930	25.22	18,000	2.44
Toulumne.....	1,500	19	1/30/11	52,600*	35.10	18,900	2.78
San Gabriel.....	2,232	18	1/1/10	12,500*	56.30	4,225	2.96
San Joaquin.....	1,637	17(a)	1/81	59,800	36.50	20,400(a)	2.93
CACHE Cr.....	600	13	2/20/09	4,340*	8.69	1,680	2.58
Feather Cr.....	3,640	12	3/19/07	187,000*	51.40	72,500	2.58
Marced.....	1,090	12	1/30/11	37,200*	34.10	13,700	2.72
Arroyo Seco.....	215	12	3/7/11	13,300	61.85	3,940	3.38
Tule.....	255	12	12/8/10	5,430	20.45	2,780	1.95
Santa Ana.....	182	12	4/1/03	4,908	26.97	1,272	3.86
CACHE Cr.....	1,230	11	2/3/09	20,800*	16.91	10,830	1.92
Yuba Cr.....	601	11	2/2/09	36,000*	59.85	16,000	2.25
Stonish.....	1,200	10	1/15/09	111,000	92.50	43,870	2.53
Stanislaus.....	935	10	3/07/09	57,300	62.20	20,600	2.78
Kaweah.....	520	10	1/21/09	9,210	17.70	4,640	1.99
NORTHERN PACIFIC COAST:							
The Dalles, Ore.....	237,000	56	6/6/94	1,160,000	4.89	661,000	1.76
Albany, Ore.....	4,860	24	1/26/03	188,000	38.85	114,800	1.64
Spokane, Wash.....	4,000	22	5/31/94	35,200	8.80	22,770	1.55
Ravensdale, Wash.....	149	18(a)	11/11	13,600	91.25	4,750(a)	2.87
Weiser, Idaho.....	1,670(g)	15	12/31/04	11,620	6.95	8,500	1.37
Unadilla.....	353	15	3/15/08	10,000(g)	28.32	3,600	2.74

NOTES.—Unless otherwise noted the above data has been compiled from the U. S. Geological Survey Reports.
 *Indicates measurement of a well-defined apex rate. Other readings in Column 6 although taken on the day of greatest flow may or may not have been at the apex.
 † Represents the average obtained by adding together the one greatest flood in each year and dividing by the number of years considered.
 (a) Years covered by record not all consecutive. (b) Since regulation of stream (1892) (c) From records of Alford and Burdick. (d) Mr. Pillsbury in *Trans. Am. Soc. C. E.*, 1914, p. 674. (e) Mr. Knowles in *Trans. Am. Soc. C. E.*, 1914, p. 650-658. (f) *Flood Flows*, in *Trans. Am. Soc. C. E.*, 1914, pp. 664-617. (g) Mr. Kuibling in *Trans. Am. Soc. C. E.*, 1914, pp. 650-658. (h) *Flood Flows*, in *Trans. Am. Soc. C. E.*, 1914, pp. 664-617. (i) The ratio of the greatest 24-hour flood flow rate to the average 24-hour rate was 3.52.

INDEX

- A
- Alleghany river, 43
America—storm paths, 80
American flood problems, miscellaneous, 43
Ancient flood works, 29
Apex flood rates, 89
Average 24-hour floods, 88
- B
- Bank clearings as loss index, 60
 protection, 118
Benefits, scope of, 63
Booms, 148
Borings, 65
Boston, rainfall at, 18, 19
Bridge openings as weirs, 72
Brush, effect on flow, 98, 99
Burr, Lieut.-Col. Edward, flood studies, 22
- C
- Cairo, great floods, 21
Cause of floods, 9
Channel betterment, types of, 97
 enlargement, 105
 flood flows, 126, 127
 flow, 122
 values, 126, 127
 improvements, 94
 Columbus, 101, 102
 cost of, Columbus, 107
 costs, 106
 effect of, 100
 on storage, 101
 reservoirs and, 95
 irregular flow in, 124
Cherry creek, Denver flood, 1912, 12
Chezy formula, 122
- Chippewa river, forests and floods.
 23
- Chittenden, Gen. H. N., 40, 41
Cincinnati, great floods, 21
Climate, effect on floods, 15
Coefficients of floods, 91
Comparison of projects, 95
 of remedies, 50
Connecticut river, gage height at
 Springfield, 20
Conservatism, 49
Cutoffs, 99
- D
- Damage, see *Loss*.
Dams, weir coefficients of, 71
Danube river floods, 84
 Vienna great floods, 21
Data, fundamental, 55
Detention basins, 35, 140
 Dublin and Delaware, 154-162
 French, 35
 land costs, 142
 Miami district, 151
 table of, 153
 Scioto, effect of, 162
Débris, 148
Delaware dam, 154
 outlet works, 161
 detention basin, operation of, 160
District boundaries, 63
Diversion of floods, 29
 works, 29
Drainage area, 12
 effect on floods, 14
Drift, 112, 148
 barriers, 148, 149
Dublin dam, 154
 drift barrier, 149
 farm land protection, 156

- Dublin dam, operation of, 154
 outlets, 157
 plan of, 155
 stilling basin, 147
 water storage, 156
- Durham, C. W., flood studies, 24
- E
- Earth dams, comparative sections, 162
- Education of public, 45
- Eno, Prof. Frank H., 116
- Erie, Pa., flood, 1915, 12
- Erosion, 114, 116, 117, 121
 Gatun spillway, 146
- European floods, 84
- F
- Factor of safety, 49
- Factors affecting flow and floods, 10
- Financial practicability, 51
- Flood profiles, 74
 rates, Kuichling data, 85, 86
 ratios, explanation of, 87
- Floods, general problem, 1
 minor, regulation of, 156, 160
 table of, 164, 169
 variation in, 95
- Flow on land, 98
 measurements, 73
 dams, 71
 effect of slope, 73
 obstructions, 72
- Forests and floods, 22, 23, 24, 25, 26
- Freezing, effect on floods, 16
- Frequency of floods, 17, 88
 of great floods, 89
- Fuller, Weston E., flood ratios, 87-93
- Fundamental data, 55
- Future floods, 82
- G
- Gage heights, 19
 long records, 20
- Gaging stations, 67
- Garonne river, France, 37
- Gates, Dublin dam, 157, 158, 159
 large, 138, 139
 needle, 138, 140
- Gatun, spillway erosion, 146
- Geological maps, value of, 63
- Germantown detention basin, 152
- Grant, Kenneth C., European reservoir data, 40
- Great floods, infrequency, 20, 21
 in U. S., table of, 164, 169
- Great Lakes system as storage reservoirs, 32
- H
- Hazards, 145
- Hazen, Allen, flood coefficients, 91
- History of floods, 82
 Europe, 84
 Scioto river, 83
- Holland, protective works, 30
- Horton, R. E., Kutter values, 123
- Huffman detention basin, 152
- Hydraulic formulæ, 118
- Hydrographs, 75
 reproduction of, 75
 Scioto and Ohio rivers, 134
 Scioto river, 132
- Hydrology, investigations, 66
- I
- Ice, 148
 gorges, 16
- Illinois river, 52, 74, 84
 effect of levees, 103
 flow values, 125, 126, 127
 natural storage, 103
 protective levees, 31
- Impartiality, advantage of, 47
- Indirect losses, 58
- Investigations for flood protection, 45
- K
- Kuichling, Emil, flood data, 86
 flood diagram, 85
- Kutter's formula, values for, 123

L

- Land cost, Scioto basins, 143
 - estimates of value, 57
 - flood damage to, 58
 - in detention basins, 142
- Lands, classifications of, 143, 144
- La Roche dam, 37
- Levee details, 106, 108, 109
 - foundations, 108
 - freeboard, 111
 - materials, 108
- Levees on channel obstructions, 31
 - Columbus, 110
 - dangers from, 53
 - effect on storage, 103
 - Mississippi practice, 109
 - protection by, 106
 - where practicable, 96
- Loire river, France, flood protection
 - on, 35, 37
- Los Angeles, Cal., flood protection
 - of, 43
- Loss, Columbus, Ohio, 5
 - Indiana, 1913, 7
 - Pittsburgh, Pa., 6
 - Scioto valley, Ohio, 5
- Losses, 3
 - and values, 56
 - Dayton, Ohio, 1913, 5
 - Hamilton, 5
 - in Ohio, 4, 5
 - Pittsburgh, Pa., 6
 - Scioto valley, Ohio, 5
 - total in U. S., 4

M

- Man, work of, effect on floods, 14
- Marietta, Ohio, rainfall at, 19
- Mead, Prof. D. W., 24, 81
- Merrimac river, forests and floods, 22
- Meta river, Russia, 40
- Miami river, 43
 - watershed subsoil, 13
- Mississippi flood problem, 40
 - gage heights 20
 - levees, investment in, 41

- Mississippi protective works, 30
 - reservoir system, 42
 - river, floods of, 84
- Missouri river, gage heights at
 - Kansas City, 20
- Monongahela river, 43
- Moore, Prof. Willis L., floods and forests, 24
- Morgan, Arthur E., rainstorm studies, 77, 78, 79

N

- New Bedford, Mass., rainfall at, 19
- Newell, F. H., 45
- New York, rainfall at, 19

O

- Obstructions as weirs, 72
- Ohio river, flood hydrograph, 134
 - gage heights at Pittsburgh, 20
- Old settler, evidence of, 84
- Origin of floods, 9
- Outlet works, Delaware detention basin, 161
- Outlets, 145
 - Dublin dam, 157, 158, 159

P

- Partial protection, 52
 - danger of, 53
- Partisanship in reporting, 48
- Pathfinder dam, concrete conduits, 146
- Philadelphia, Pa., rainfall at, 19
- Physiography, 61
- Pinay dam, 37
- Pittsburgh, greatest floods, 21
 - flood problem, 43
 - reservoirs, 44
- Popular beliefs, 17
 - belief, basis, 26
- Practicability from financial standpoint, 51
- Precipitation, 11
- Prevention of floods, 28, 128

- Preventive works, 32
 Protection works, 30
 from floods, 28, 94
 Provisional floods, 82
 Psychology of reporting, 46
 Public works, stages of, 45
- R**
- Rainfall, 128
 influence on floods, 76
 records, 18
 Rainstorms, great, 76, 78, 79
 path of, 80
 Rating curves, 67
 construction, 69
 Ratio, hourly max. to ave., 89
 max. to ave. flood, 90
 Ratios applied to floods, 87
 greatest floods, 92
 great floods, table, 164, 169
 Records and popular beliefs, 17
 importance of length, 18
 of stream flow, 66
 Remedies for floods, 28
 Reports, 46
 Reservoir system, Mississippi, 42
 Ottawa river project, 42
 Reservoirs, automatic control, 34
 conflicting purposes, 150
 European, 36
 table of, 38, 39
 flood protection of Pittsburgh,
 44
 for flood protection, 32
 for several purposes, 33
 French, 37
 German and Austrian, 37
 large, miscellaneous, 40
 location, 137
 Spanish, 40
 Rhone river, France, 37
 Rip rap, 118
 River control, European, 36
 Roanne, France, flood protection, 35
 Runoff, annual, 128, 129
 flood total, 70
 great floods, table of, 164, 169
 seasonable regularities, 129, 130
- S**
- Sacramento, Cal., flood protection
 of, 43
 Safety factor, 49
 St. Croix river, forests and floods,
 23
 St. Lawrence river, uniformity of
 flow, 32
 Saline river, 100
 Sangamon river, 100
 Scioto river, channel flow values, 127
 effect of storage, 136, 141
 hydrograph of, 132
 valley, flood benefits, 154
 flood relief, 153
 watershed subsoil, 13
 Seasonal floods, 33
 Seine river, flood frequency, table,
 25
 France, 84
 Paris, great floods, 21
 Slope, determination, errors of, 73
 Smoothness, effect on flow, 98
 Sod, erosion preventive, 119, 120
 Spillways, 145
 Standing wave, 146
 Stewart, Clinton B., rainstorm
 studies, 77
 Stilling basins, 147
 Stoney gates, 139
 Storms, path of, 80
 Storage at apex, 104
 automatic, 141
 effect of Scioto river, 133, 136
 for flood relief, 128
 for floods, 131
 incidental uses, 131
 natural, 13, 101, 104
 on flood plain, 100, 101
 Scioto and Ohio rivers, 135
 underground, 129
 Stream flow, distribution of, 128
 seasonable irregularities, 129,
 130
 Studies for flood relief, 21
 Surface ground, effect on floods, 13
 Surveys, 61
 cost of, 64

T

- Tendencies, future floods, 16
 - summarized, 27
- Timber, effect on flow, 98, 99
- Topography, effect on floods, 13
 - on relief works, 96
 - of streams, 63
- Types of relief works, 28

U

- Underground conditions, 65

V

- Values and losses, 56
- Variation in flood flow, 9
- Vegetation, effect on flow, 14, 99

- Velocity control, 117
 - limiting, 113
- Velocities at outlets, 146
 - canals, 114
 - effect of, 119
 - of floods, 115
 - limiting, Dubuat, table, 114
 - rivers, 115
- Volga river, Russia, 40

W

- Watershed area and runoff, 77
 - effect of, 12
- Weirs, coefficients dams, 71
- Willcocks, Sir William, ancient flood works, 29, 30
- Wilson, H. M., canal velocities, 114
- Wisconsin, forests and floods, 23

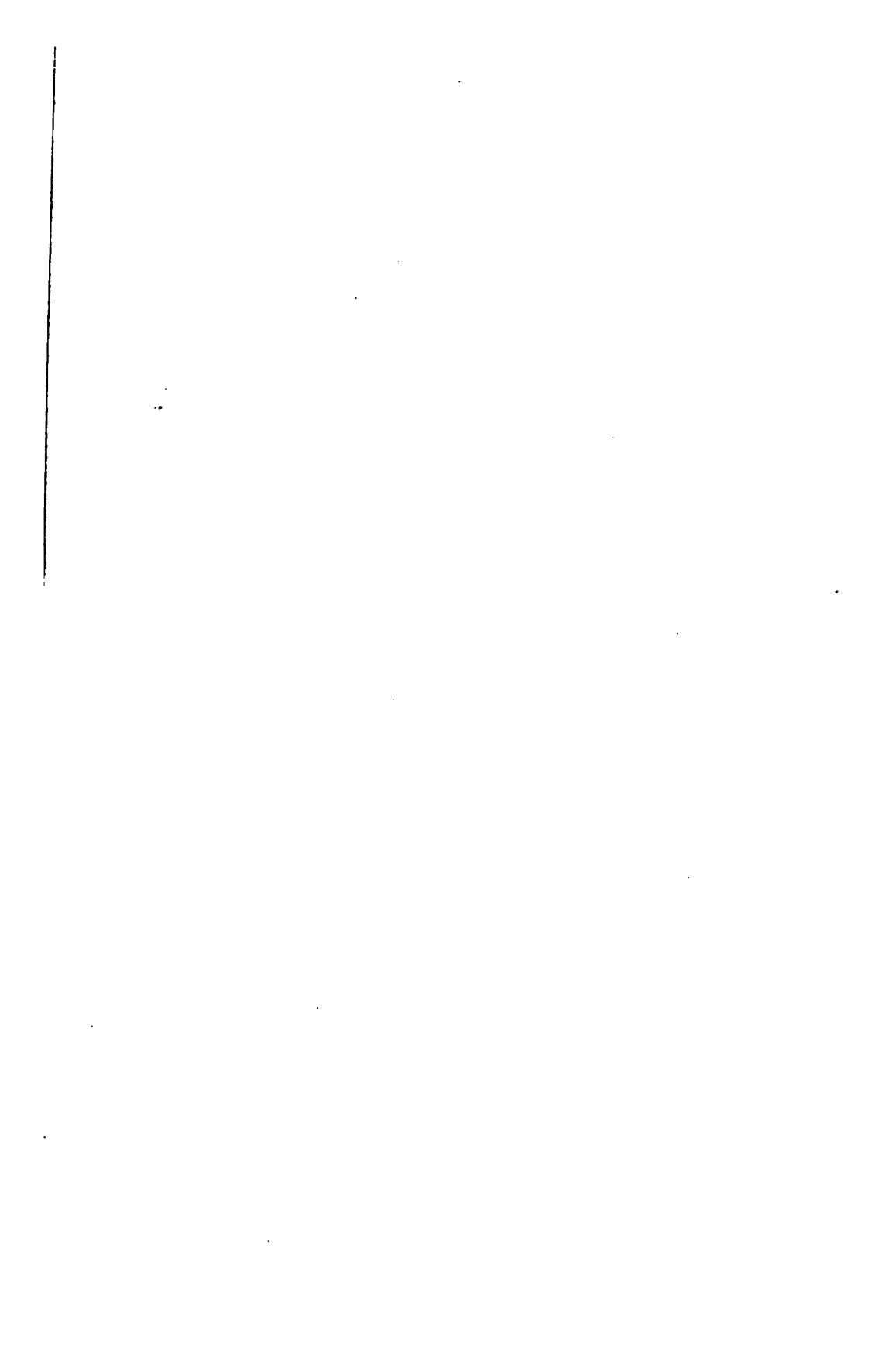

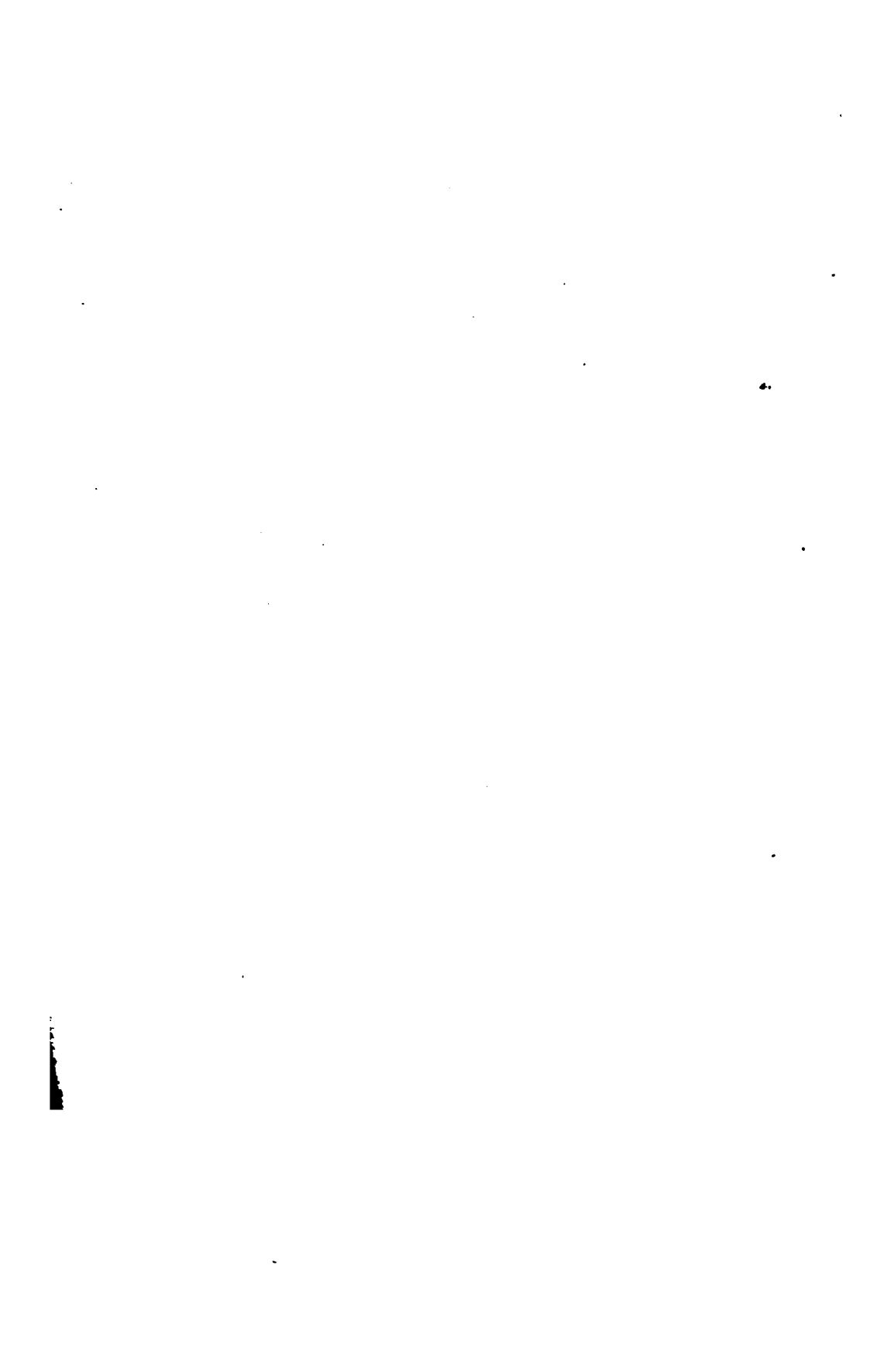

1

1

